

Thank you for the order! We appreciate and welcome your business. Timberline Cabinet Doors, Inc. has manufactured cabinet doors since 1995 providing consistent lead times, competitive pricing and excellent quality to cabinetmakers across the western United States.

General Statement of Services

We specialize in the manufacturing and timely delivery of quality Wood doors, and Drawer fronts in any wood type. These door styles are manufactured to your specifications and are sold to cabinet contractors/manufacturers. We do not stock finished items since each order is custom made. Please utilize our experience to meet your special needs!

Guarantee

Doors within our maximum sizes (**24" X 42"**) are guaranteed against warpage, swelling or twisting by Timberline Cabinet Doors for one year from delivery, **when given reasonable treatment.**

Reasonable treatment requires doors and drawer fronts to:

- Be stored in areas not subject to abnormal heat, cold, dryness, humidity, or direct sunlight.
- Not be stored in freshly plastered buildings or damp and humid open areas.
- Not be subject to extreme Moisture (bleaching etc.)
- Not be subject to impairment of structural strength when fitting or applying hardware.
- Be finished on front, back, top, bottom, and sides with an equal amount of finish, as soon as possible to prevent unequal absorption or release of moisture.

Guarantee Reminders:

- A warp or twist of 3/16 of an inch or less is not considered a defect. Twists are measured by placing the face of the door against a true plane surface.
- Any requested variations from our normal construction specifications are not guaranteed (e.g. reducing thickness of a panel).
- Doors and drawer fronts must be inspected upon receipt by our customer.
- All guarantee claims must be inspected by Timberline Cabinet Doors prior to applying finishes or stains. Once stained or finished customer has accepted the product as an acceptable product (this also includes measuring for correct sizes).

The warranty covers replacement or repair of doors or drawer fronts in an unfinished state and in good condition as originally delivered FOB our factory. Our liability under this warranty is limited to the net invoice price of the doors as sold by us. There are no other warranties of any kind, expressed or implied.

Quotes (valid for 30 days)

Timberline Cabinet Doors offer a written quote service on non-specialty items with three working days. You can also request a quote on specialty items, which will require more time. Please, write, "Quote only" on order. Specialty items include:

- Special woods
- Multi-panel doors (wainscot paneling)

Shipping / Delivery Notes

Holiday Schedule

Holidays observed by Timberline Cabinet Doors, Inc. which will affect our delivery schedule are: New Years, Memorial Day, Independence Day, Thanksgiving Day and the following Friday, Christmas Day and the following day. Please order early and confirm delivery dates.

Timberline Cabinet Doors Delivery Truck

Timberline Cabinet Doors, Inc. whenever possible arranges delivery by our own trucks. Deliveries to surrounding areas are \$15 - \$35 depending on your location.

Rush Delivery & Last Minute Changes

Please identify any rush delivery needs and we will do our best to accommodate these needs. Special Handling charges will be assessed to orders that required rush delivery.

- Same day (8 hrs)---- additional 80%
- 1 day (24 hrs)----- – additional 60%
- 2 day (48 hrs)----- – additional 40%
- 3 day (72 hrs)-----additional 20%

Ordering Guidelines

General Information

Orders can be faxed to Timberline 24 hours a day (435) 586-6756. We always confirm orders via fax confirmations. Orders changed after the order has been started, will be charged for time and materials.

Confirmation of Phone orders

Please listen carefully and check your order when we read it back to you. The Read Back is your confirmation of the order. Any correction not made during the Read Back becomes your responsibility.

Information required on all orders

* Job Name *Wood Type *Door Style *Panel Profile *Edge Detail

Terms & Tax

Orders from new customers are subject to a 50% deposit. Terms are COD unless **pre-arranged** by our office manager. All sales are taxable, unless we have an original signed Resale form, on file at Timberline Cabinet Doors, Inc. prior to the time of invoice. Any changes made to invoices or changes regarding the condition of goods being shipped must be presented in writing within 15 days.

Manufacturing Considerations

- You may request an additional center stile or center rail on most doors (+extra labor cost).
- If you require special color or grain, you must supply us with a sample and make note of your requirements at the time of ordering. Our best effort will be done in matching your sample material to your order. Please remember wood is a natural product and it is not always possible to get an exact match. An additional charge may be assessed.
- All doors and drawer fronts are manufactured to the nearest 1/16" unless ordering "exact sizing" which will result in a 1/32" tolerance.
- Paint grade materials are listed as paint grade – Alder, Maple, or Poplar. Other materials may be painted but are not guaranteed.
- A set-up charge is assessed to some Stile and Rail profiles and some Edges.

How to Price

Example

Door style labor cost -111

Material cost-----Select Oak

E1 (standard)-----E1

P1 (standard)-----P1

Price = Labor Cost + Material Cost

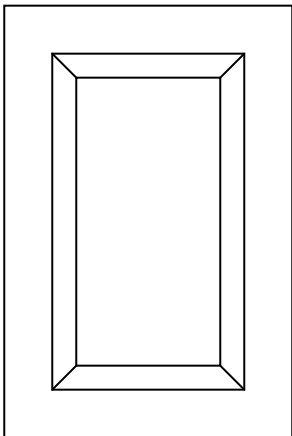

STEP 1. Select the appropriate Labor Price from the Price List :

111 = \$11.85 Labor Cost Per Door

STEP 2. Calculate the Material Charge:

A. 18" X 26" / 144 = 3.25 sq. ft.

B. Select the appropriate Material Cost from the price list.
Select Oak = \$5.39

C. 3.25 sq.ft. X \$5.39 = \$17.51

STEP 3. Add: Labor + Material = Door Price

\$11.85 + \$17.51 = \$29.36

Average Price / Sq Ft:*

\$29.36 / 3.25 sq. ft. = \$9.034 sq. ft.

SLAB

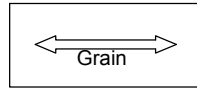

100

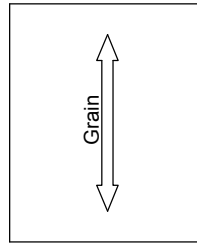

110

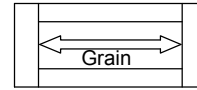

101

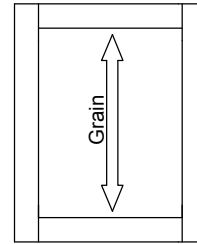

111

CATHEDRAL

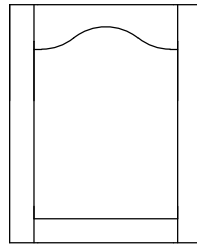

112

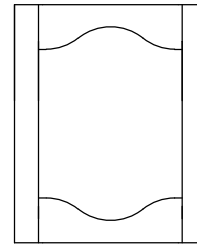

113

EYEBROW

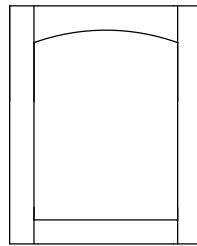

115

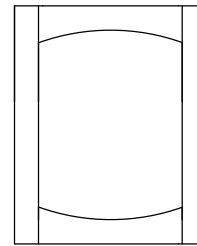

116

TIFFANY

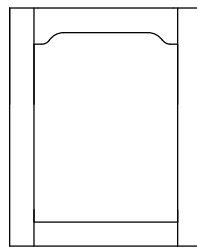

117

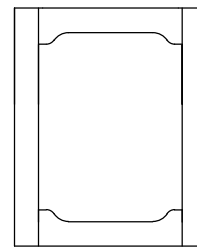

118

TEARDROP

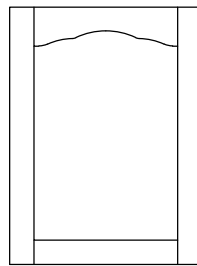

119

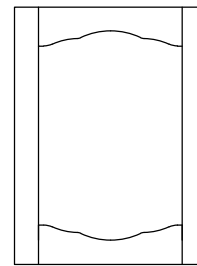

120

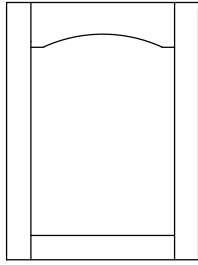

121

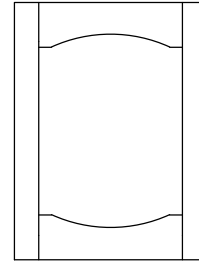

122

TIFFANY
LARGE

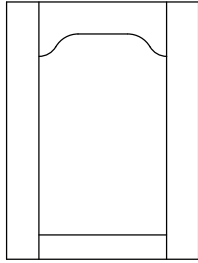

123

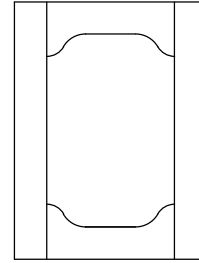

124

TUSCANY

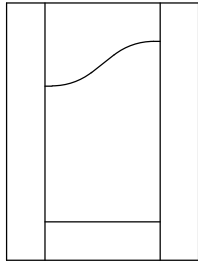

125-L

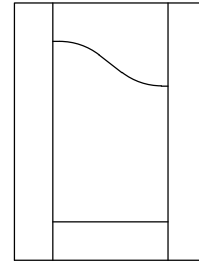

125-R

DRAWER
FRONT

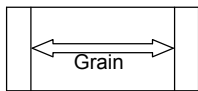

130
Drawer Front

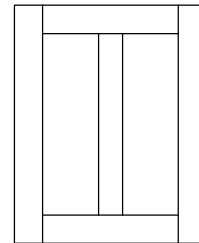

142

4 GRID

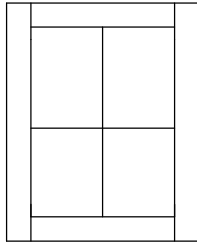

6 GRID

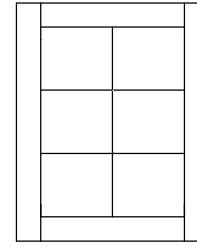

8 GRID

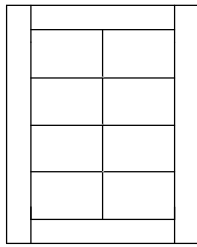

9 GRID

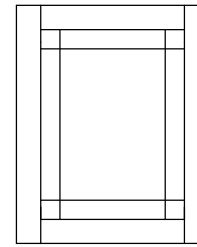

FRENCH LITE PATTERNS



787 N. 2150 W. Circle Cedar City, Utah 84721
(435) 586-6776 (435) 586-6756 fax

4-3-14

6

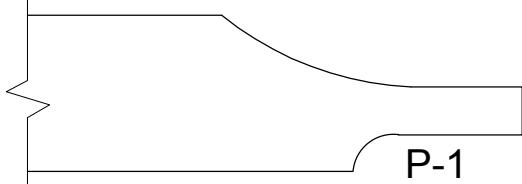

P-1

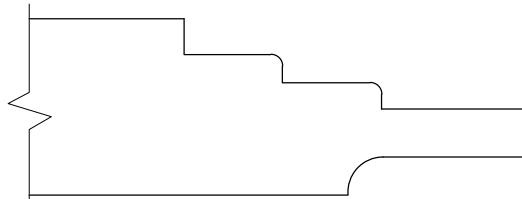

P-8

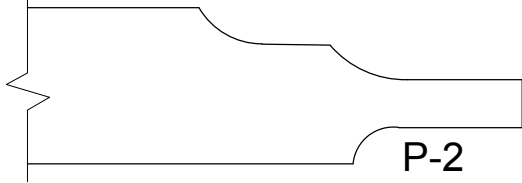

P-2

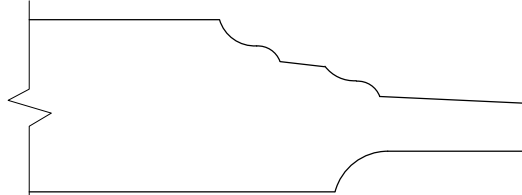

P-9

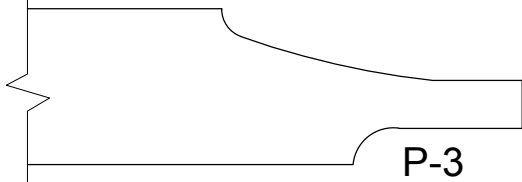

P-3

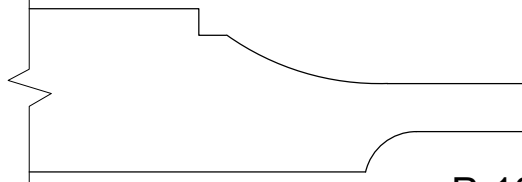

P-10

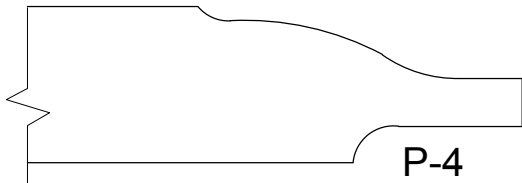

P-4

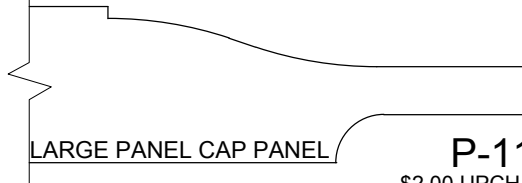

LARGE PANEL CAP PANEL

P-11

\$2.00 UPCHARGE
PER PANEL

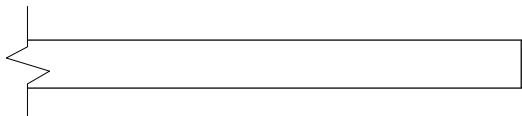

P-5

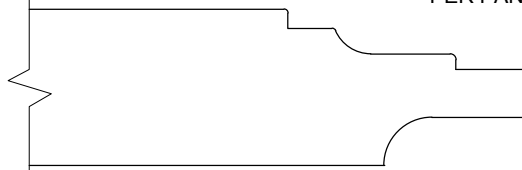

P-12

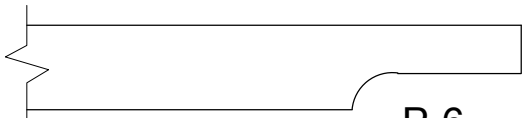

P-6

\$2.30 UPCHARGE
PER PANEL

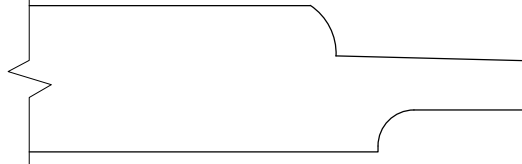

P-13

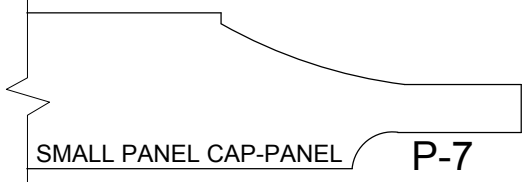

SMALL PANEL CAP-PANEL

P-7

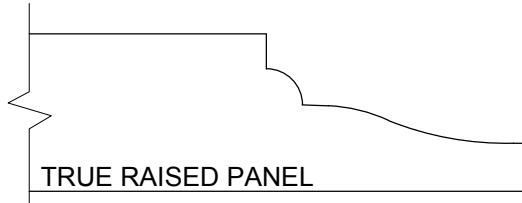

TRUE RAISED PANEL

P-14

\$12.00 UPCHARGE
PER PANEL

PANEL PROFILES



787 N. 2150 W. Circle Cedar City, Utah 84721
(435) 586-6776 (435) 586-6756 fax

4-3-14

7

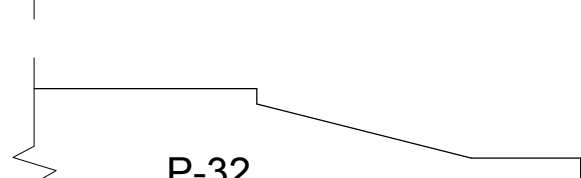
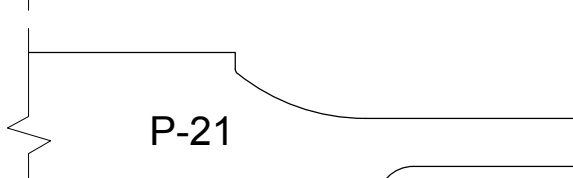
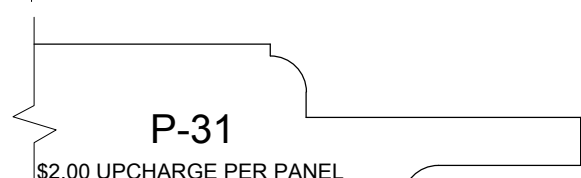
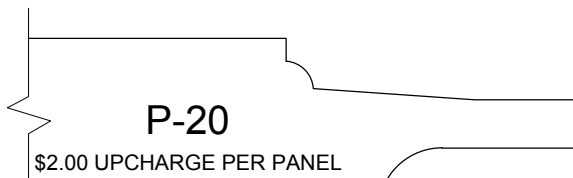
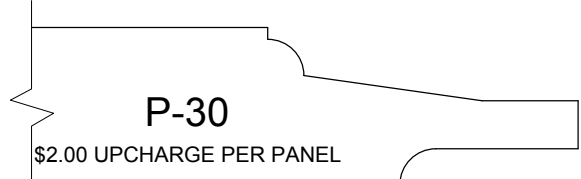
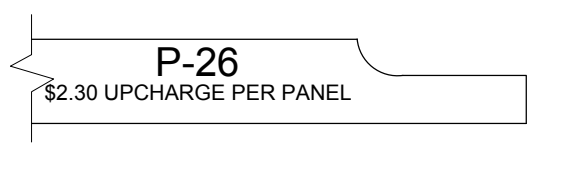
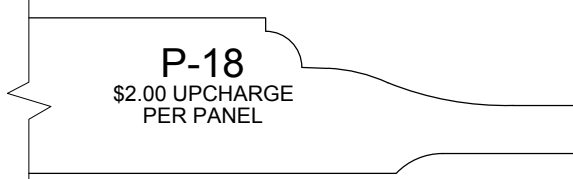
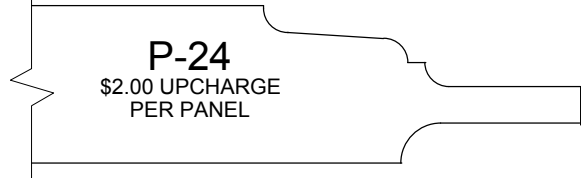
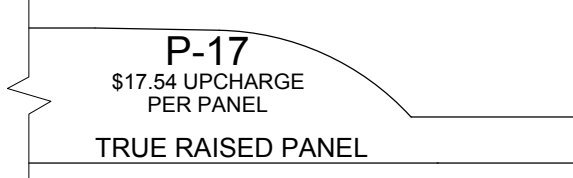
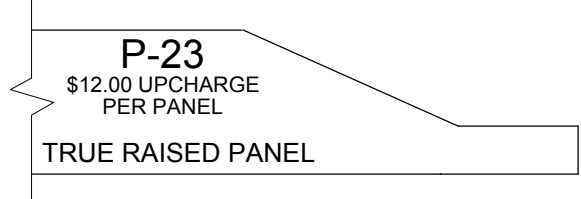
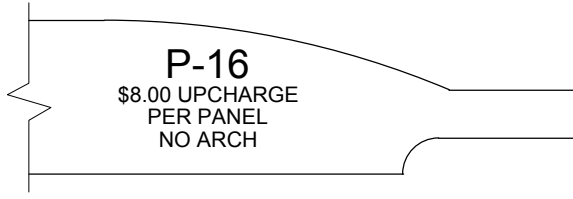
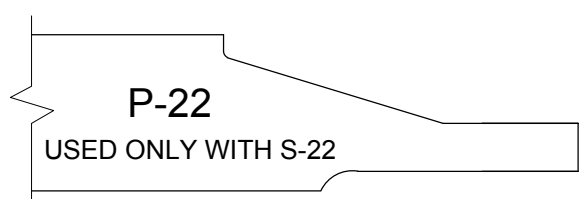
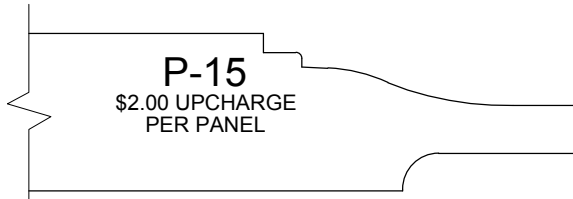

PANEL PROFILES



787 N. 2150 W. Circle Cedar City, Utah 84721
(435) 586-6776 (435) 586-6756 fax

4-3-14

8

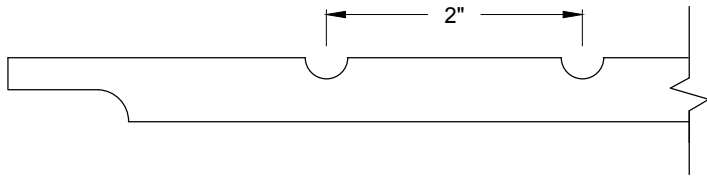

WITH FLUTING

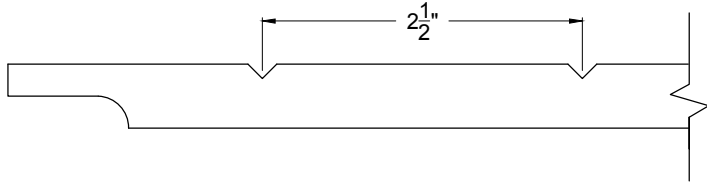

WITH V GROOVE
AVAILABLE ON P-1, P-6, P-8, & P-10

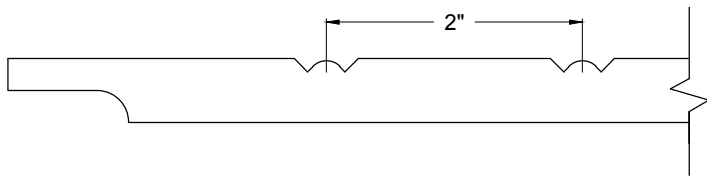

WITH BEADBOARD
AVAILABLE ON P-1 & P-6

PANEL MODIFICATIONS

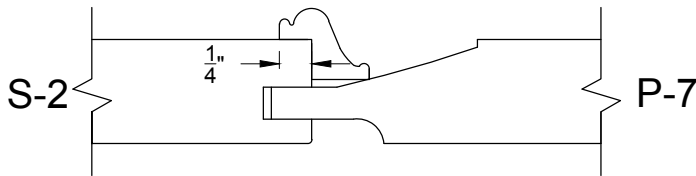

SMALL PANEL CAP DOOR

SEE APPLIED MOLDINGS FOR MORE OPTIONS

PANEL CAP ALSO AVAILABLE ON P-6 AND CAN BE USED WITH ML-11

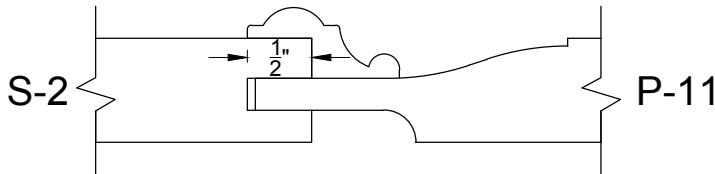

LARGE PANEL CAP DOOR

APPLIED MOLDINGS



787 N. 2150 W. Circle Cedar City, Utah 84721
(435) 586-6776 (435) 586-6756 fax

4-3-14

9

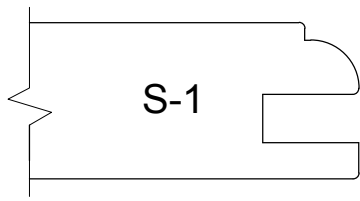

S-1

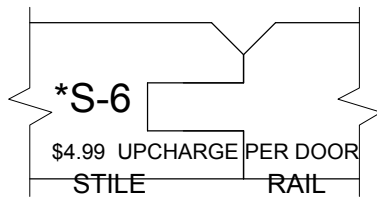

*S-6

\$4.99 UPCHARGE PER DOOR

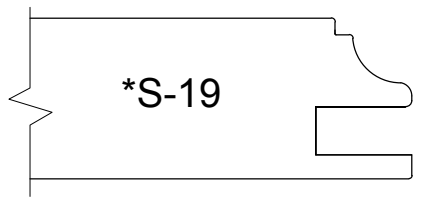

*S-19

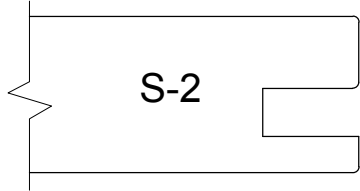

S-2

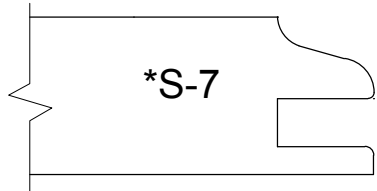

*S-7

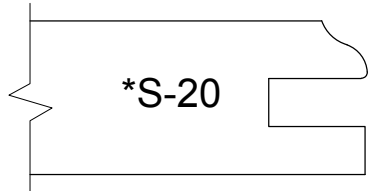

*S-20

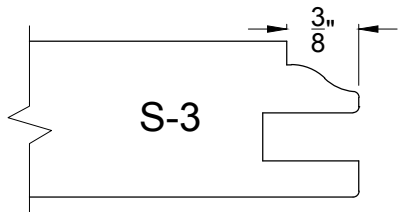

S-3

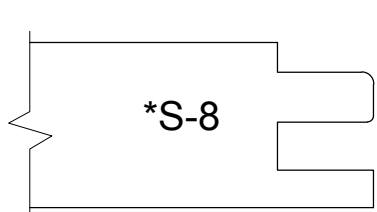

*S-8

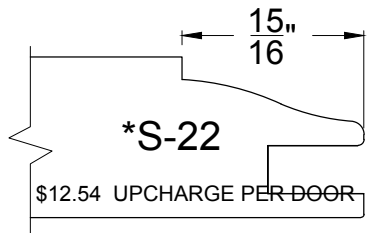

*S-22

\$12.54 UPCHARGE PER DOOR

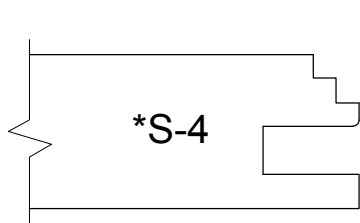

*S-4

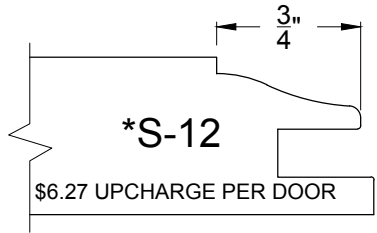

*S-12

\$6.27 UPCHARGE PER DOOR

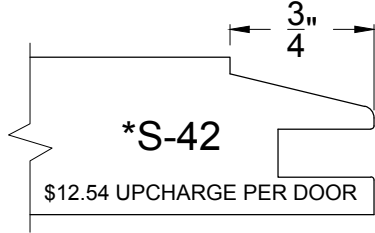

*S-42

\$12.54 UPCHARGE PER DOOR

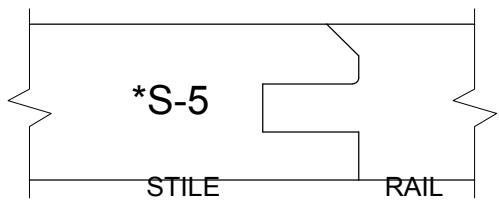

*S-5

STILE RAIL

CANNOT BE USED WITH ALL PANEL PROFILES

STILE & RAIL PROFILES

* \$15.00 SET-UP FEE



787 N. 2150 W. Circle Cedar City, Utah 84721
(435) 586-6776 (435) 586-6756 fax

4-3-14

10

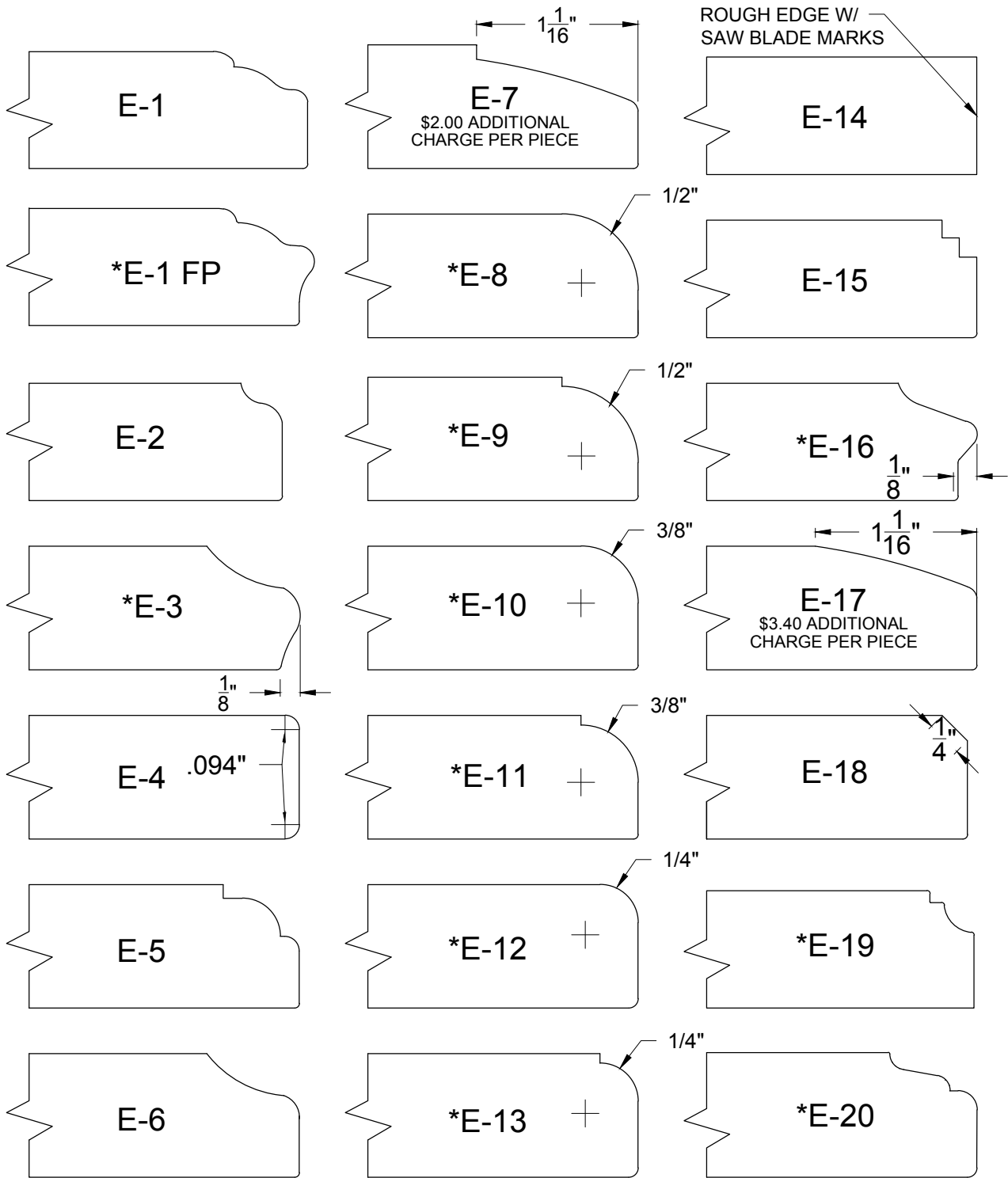

EDGE DETAIL

*\$0.85 ADDITIONAL CHARGE PER PANEL



787 N. 2150 W. Circle Cedar City, Utah 84721
 (435) 586-6776 (435) 586-6756 fax

4-3-14

11

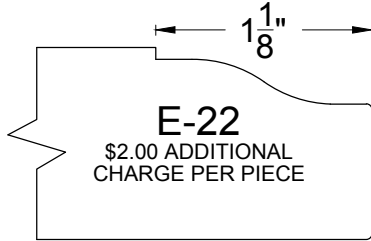
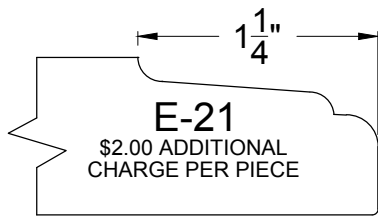

1" THICK MATERIAL REQUIRED

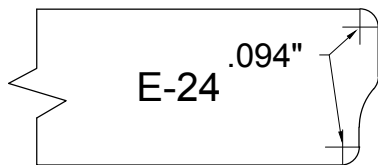
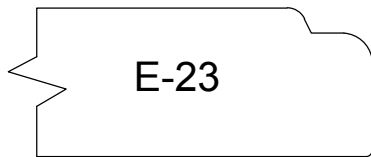

EDGE DETAIL

*\$0.85 ADDITIONAL CHARGE PER PANEL



787 N. 2150 W. Circle Cedar City, Utah 84721
(435) 586-6776 (435) 586-6756 fax

4-3-14

12

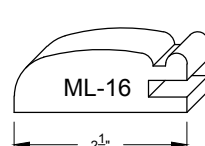
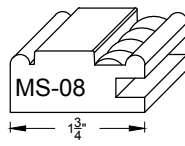
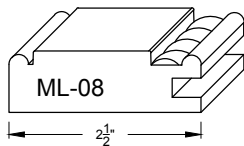
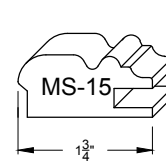
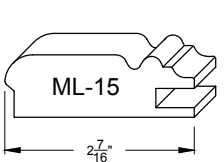
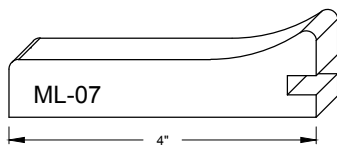
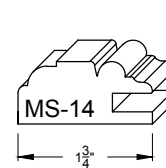
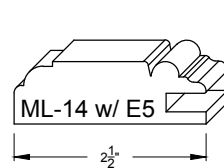
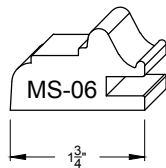
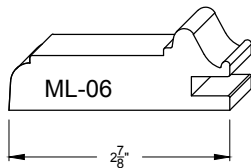
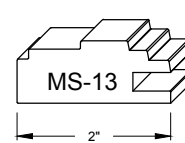
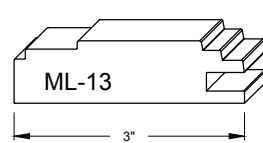
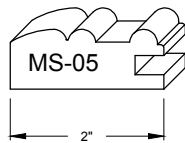
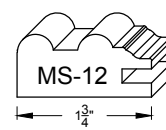
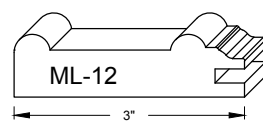
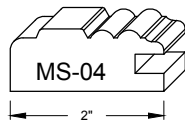
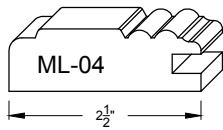
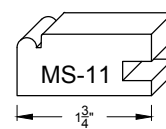
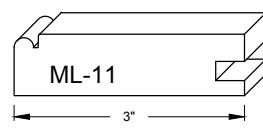
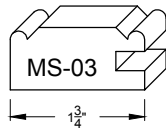
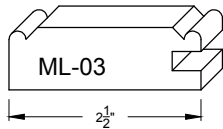
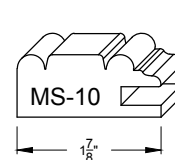
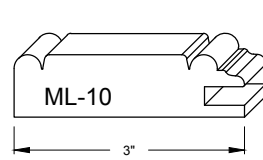
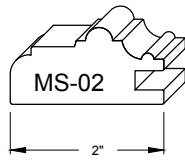
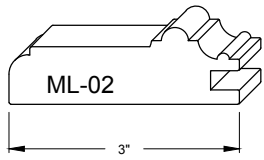
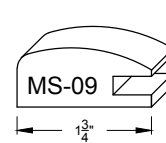
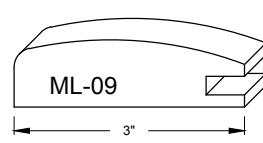
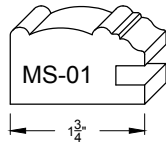
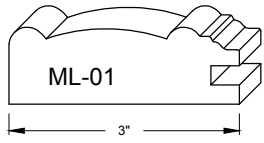

MITERED DOOR STYLES



787 N. 2150 W. Circle Cedar City, Utah 84721
(435) 586-6776 (435) 586-6756 fax

4-3-14

13

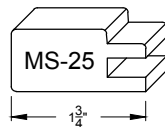
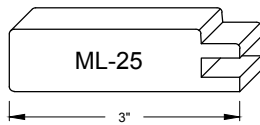
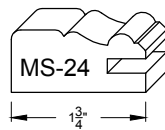
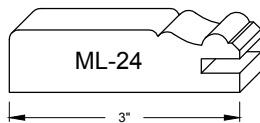
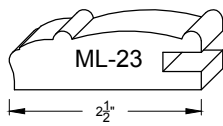
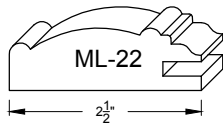
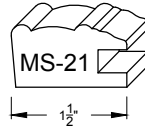
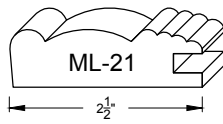
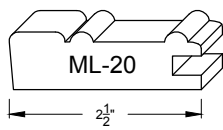
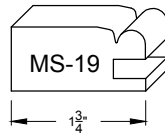
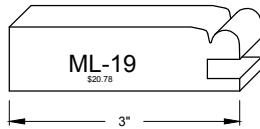
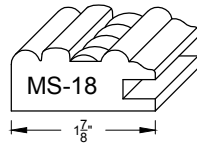
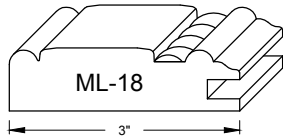
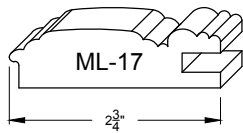

MITERED DOOR STYLES



787 N. 2150 W. Circle Cedar City, Utah 84721
(435) 586-6776 (435) 586-6756 fax

4-3-14

14

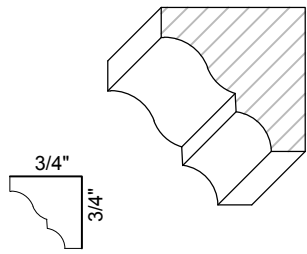

3/4" X 3/4"
CM-10

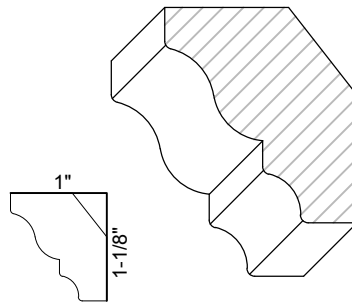

5/8" X 1-1/2"
CM-15

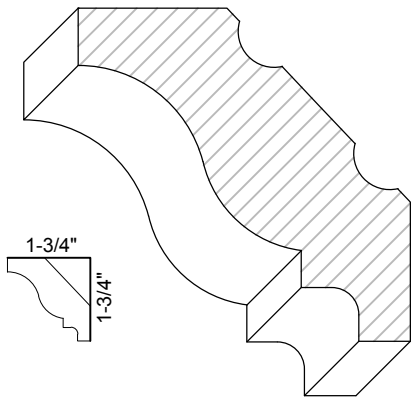

3/4" X 2 1/2"
*CM-21

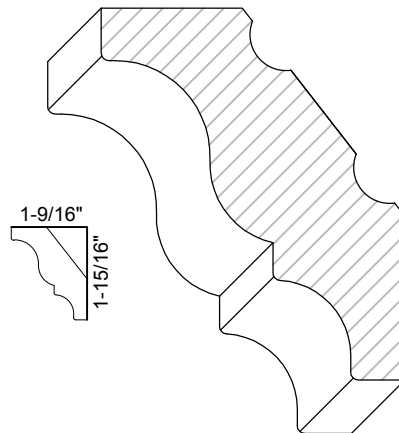

3/4" X 2 1/2"
CM-22

CROWN MOLDING

** CALL FOR PRICING

* STOCKED PROFILE



787 N. 2150 W. Circle Cedar City, Utah 84721
(435) 586-6776 (435) 586-6756 fax

4-3-14

1

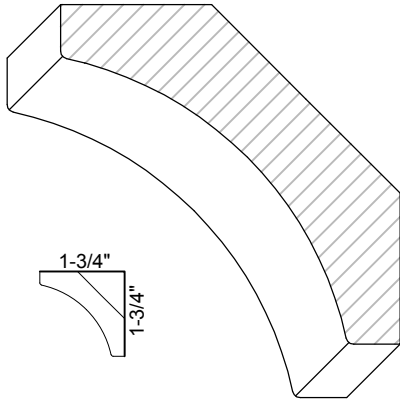

3/4" x 2-1/2"
CM-23

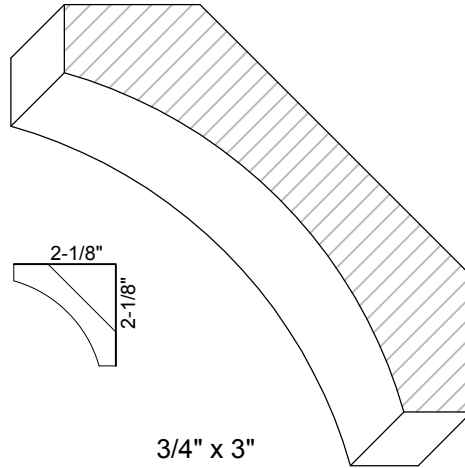

3/4" x 3"
CM-36

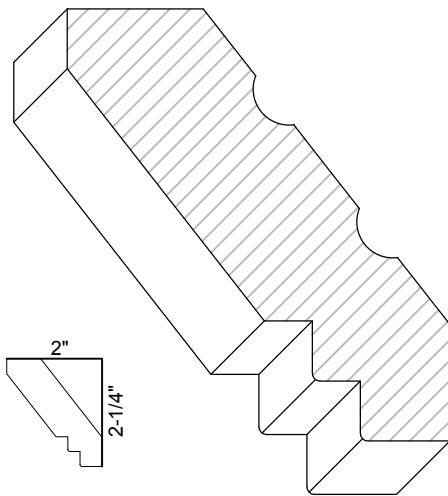

3/4" x 3"
CM-30

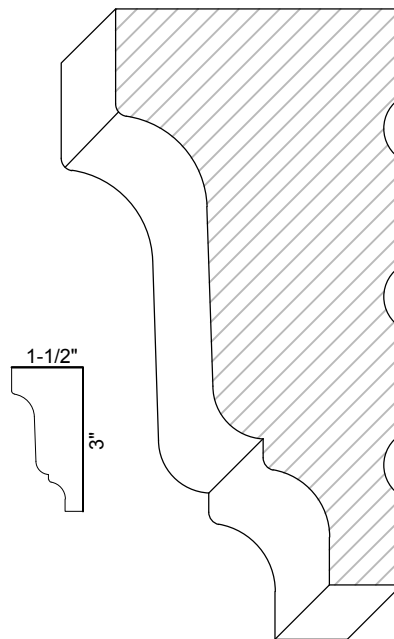

1-1/2" X 3"
**CM-31

CROWN MOLDING

** CALL FOR PRICING

* STOCKED PROFILE



787 N. 2150 W. Circle Cedar City, Utah 84721
(435) 586-6776 (435) 586-6756 fax

4-3-14

2

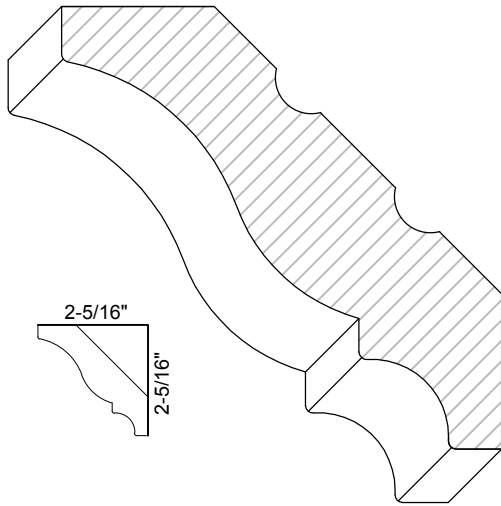

3/4" X 3-1/4"
*CM-32

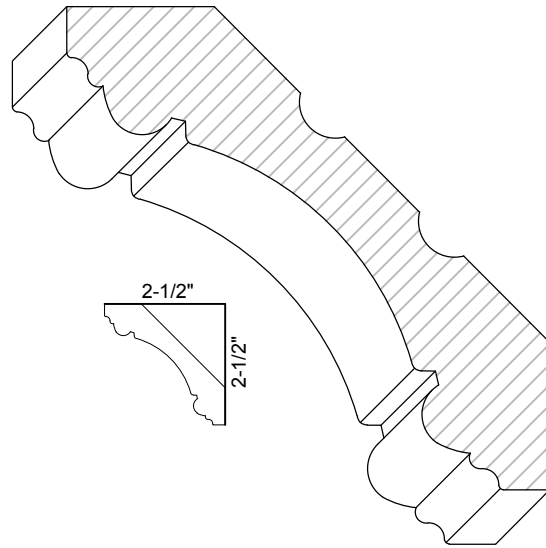

3/4" X 3-1/2"
CM-33

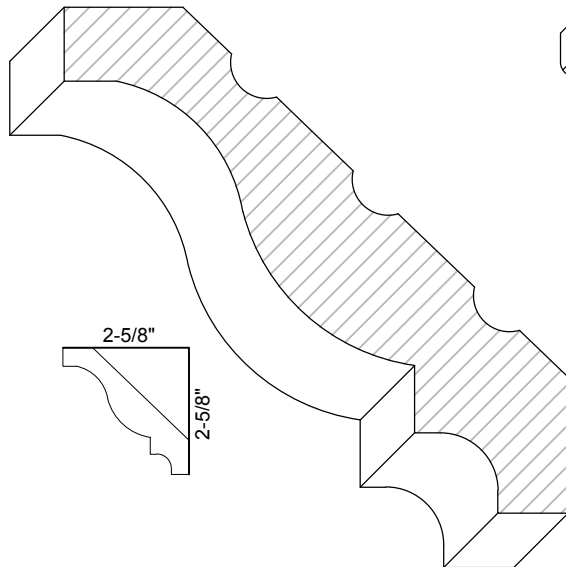

3/4" X 3-3/4"
*CM-34

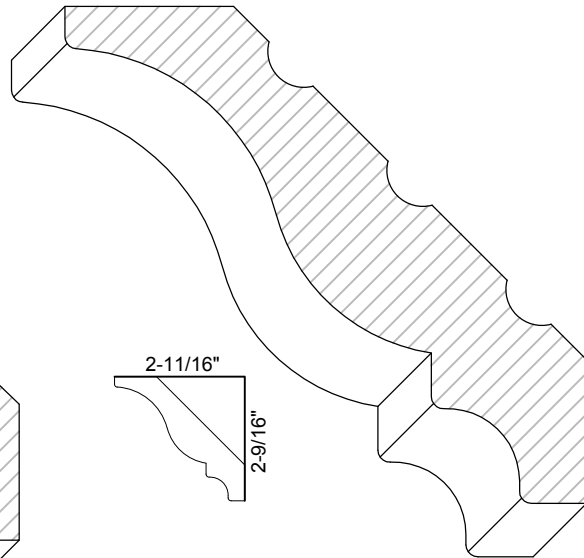

13/16" X 3-3/4"
CM-35

CROWN MOULDING

* STOCKED PROFILE



787 N. 2150 W. Circle Cedar City, Utah 84721
(435) 586-6776 (435) 586-6756 fax

4-3-14

3

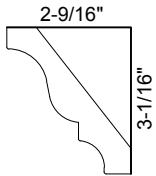
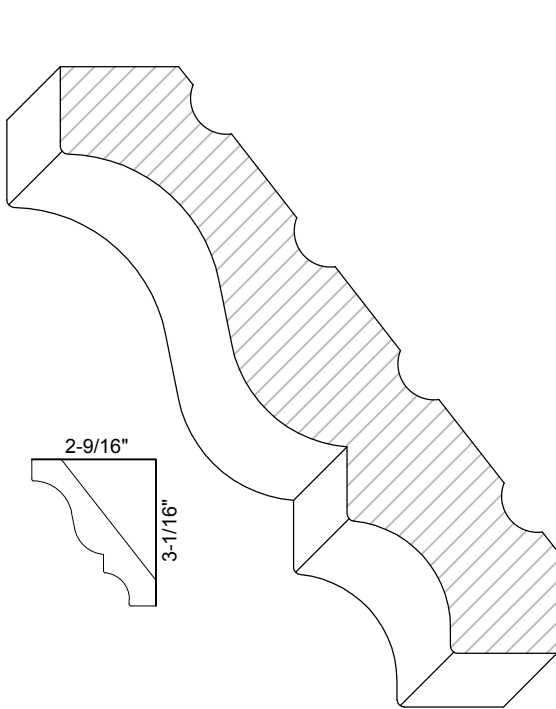

3/4" X 4"
*CM-40

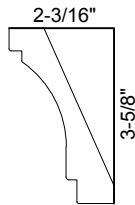
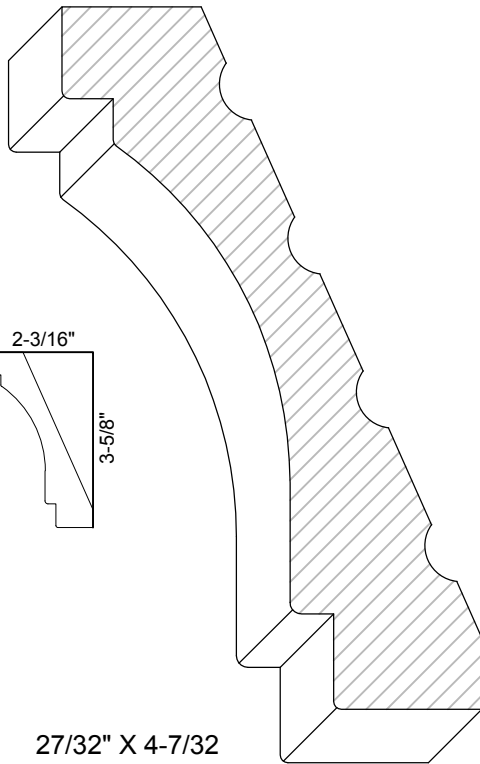

27/32" X 4-7/32
CM-41

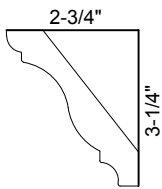
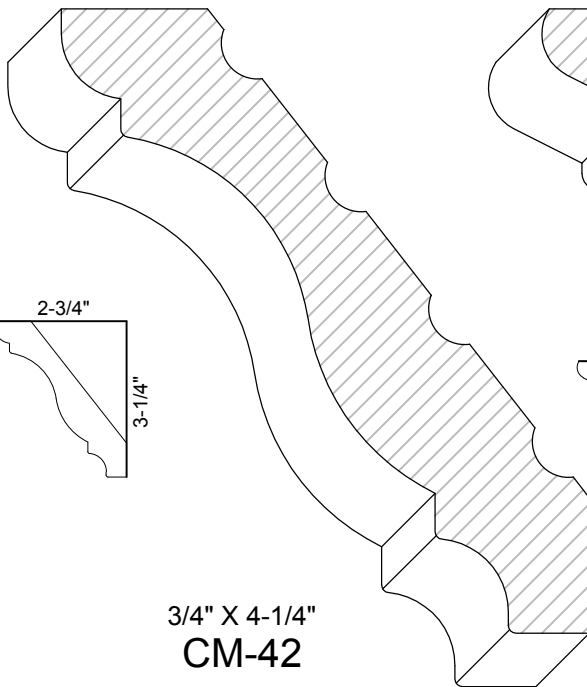

3/4" X 4-1/4"
CM-42

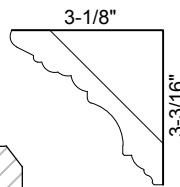
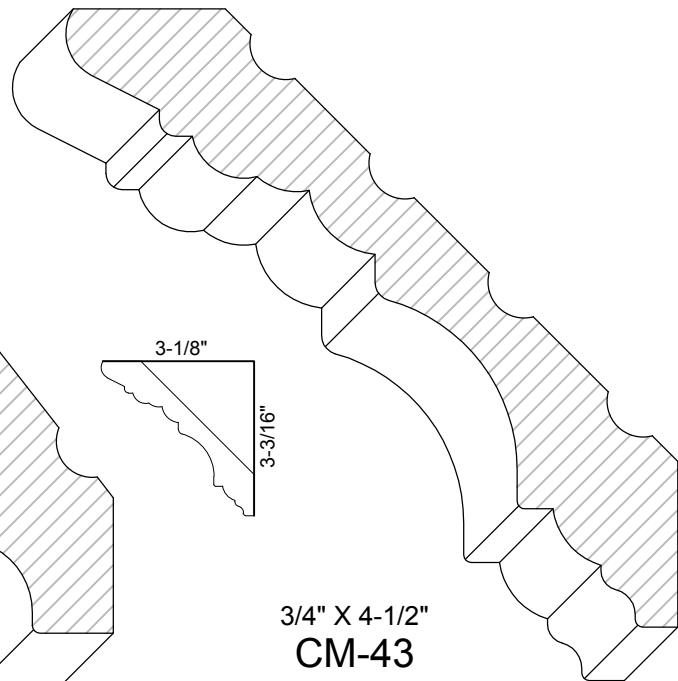

3/4" X 4-1/2"
CM-43

CROWN MOULDING

* STOCKED PROFILE



787 N. 2150 W. Circle Cedar City, Utah 84721
(435) 586-6776 (435) 586-6756 fax

4-3-14

4

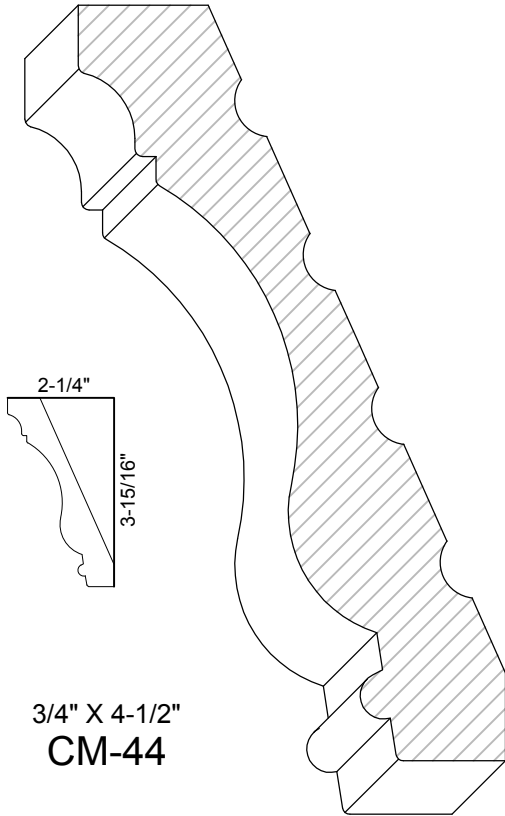

3/4" X 4-1/2"
CM-44

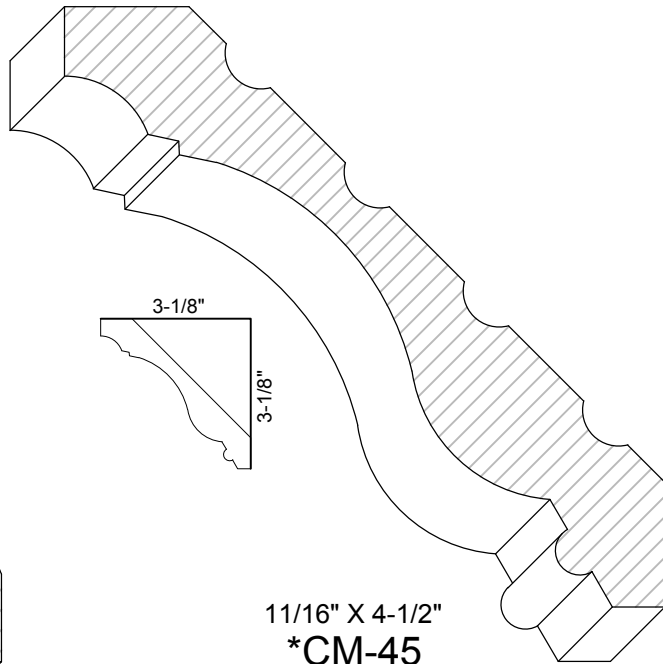

11/16" X 4-1/2"
*CM-45

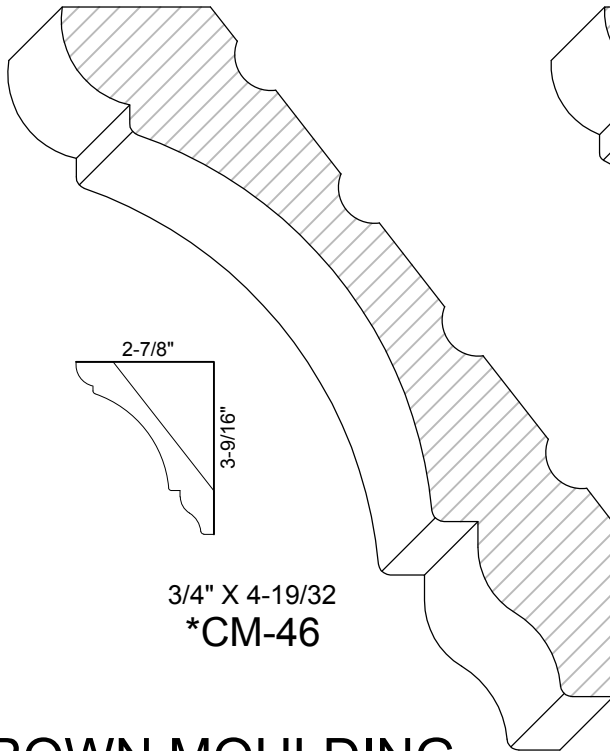

3/4" X 4-19/32
*CM-46

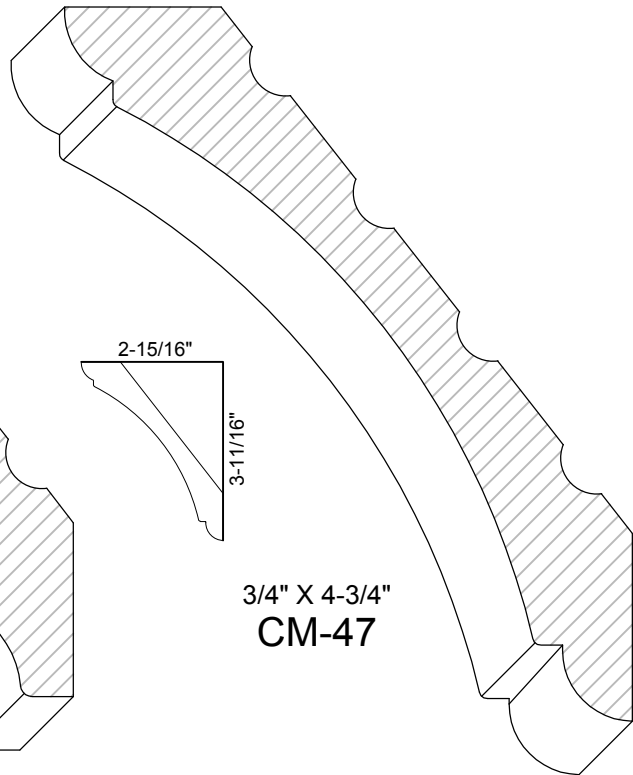

3/4" X 4-3/4"
CM-47

CROWN MOULDING

* STOCKED PROFILE



787 N. 2150 W. Circle Cedar City, Utah 84721
(435) 586-6776 (435) 586-6756 fax

4-3-14

5

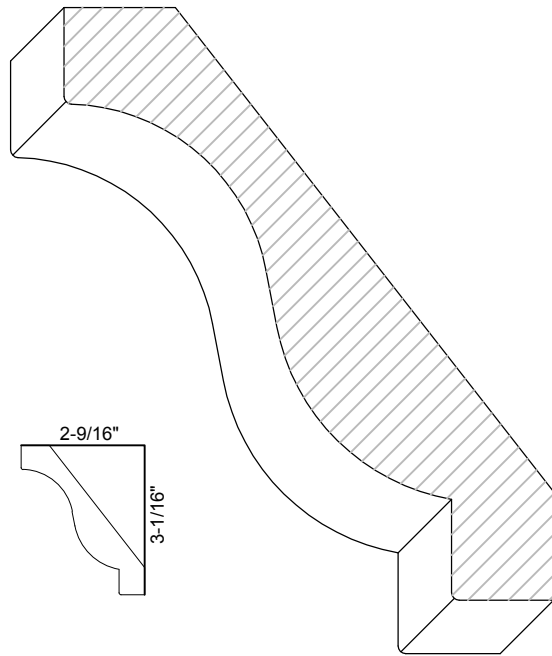

3/4" X 4"
CM-48

CROWN MOULDING

* STOCKED PROFILE



787 N. 2150 W. Circle Cedar City, Utah 84721
(435) 586-6776 (435) 586-6756 fax

4-3-14

6

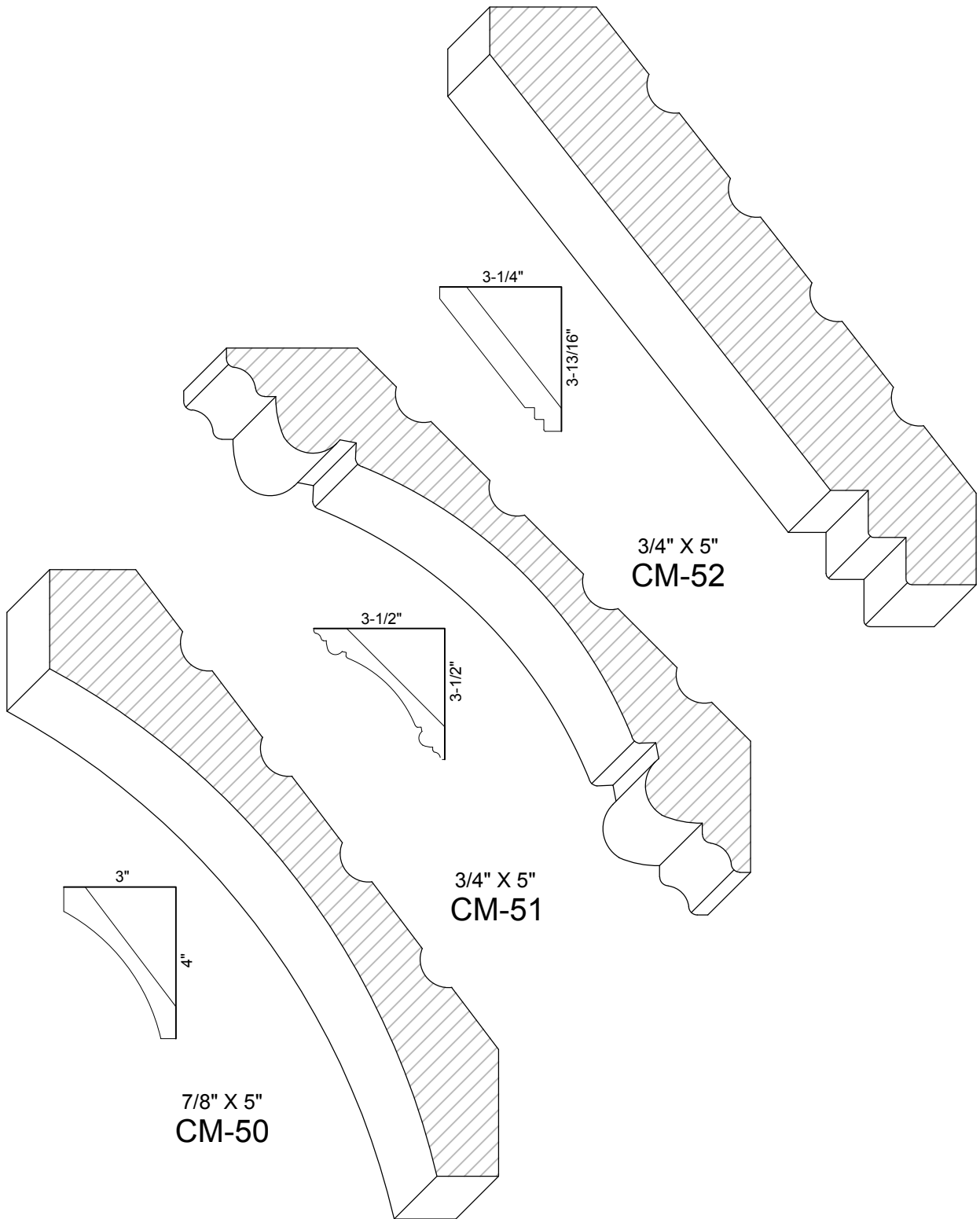

CROWN MOULDING

* STOCKED PROFILE



787 N. 2150 W. Circle Cedar City, Utah 84721
(435) 586-6776 (435) 586-6756 fax

4-3-14

7

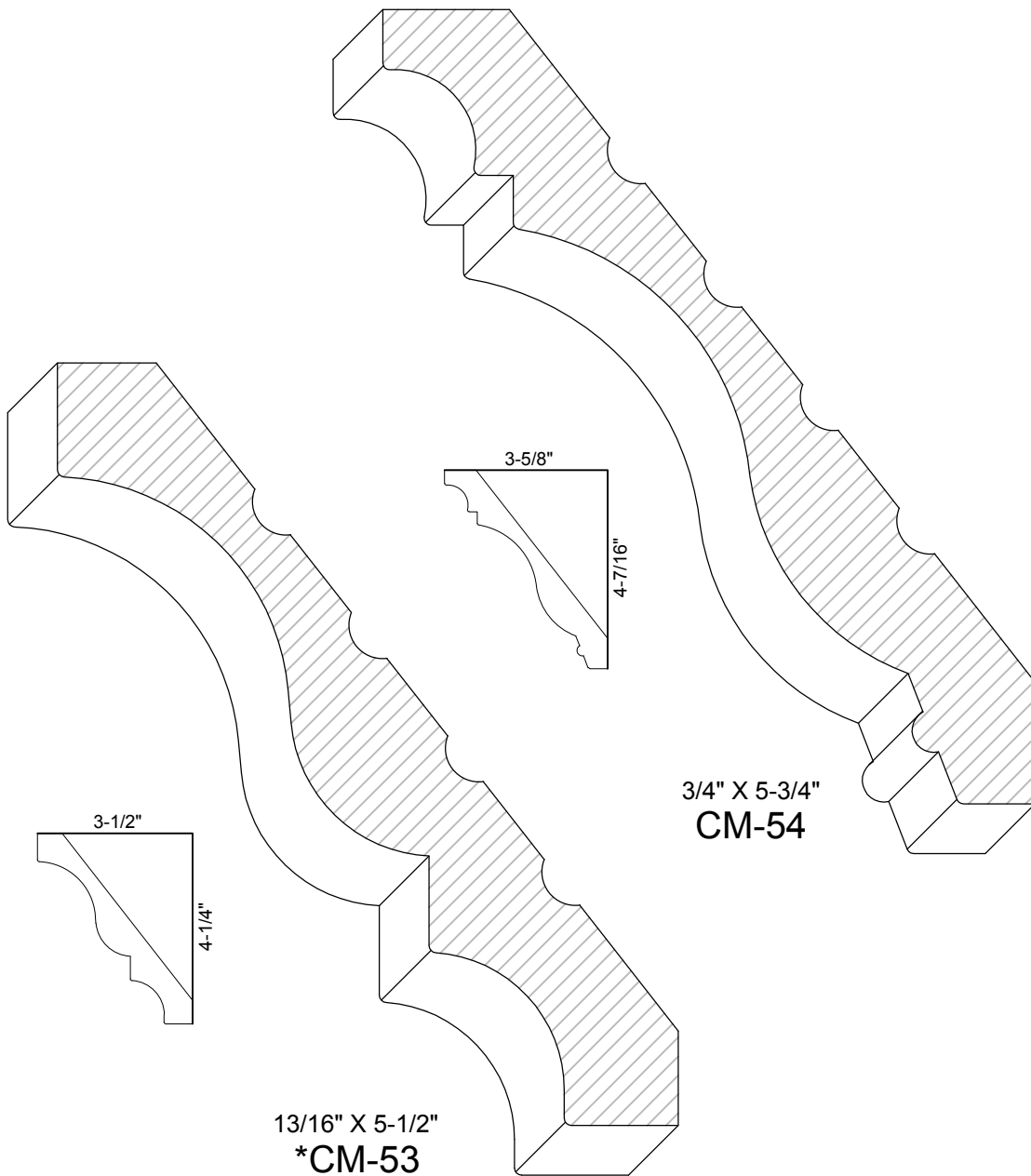

CROWN MOULDING

* STOCKED PROFILE



787 N. 2150 W. Circle Cedar City, Utah 84721
(435) 586-6776 (435) 586-6756 fax

4-3-14

8

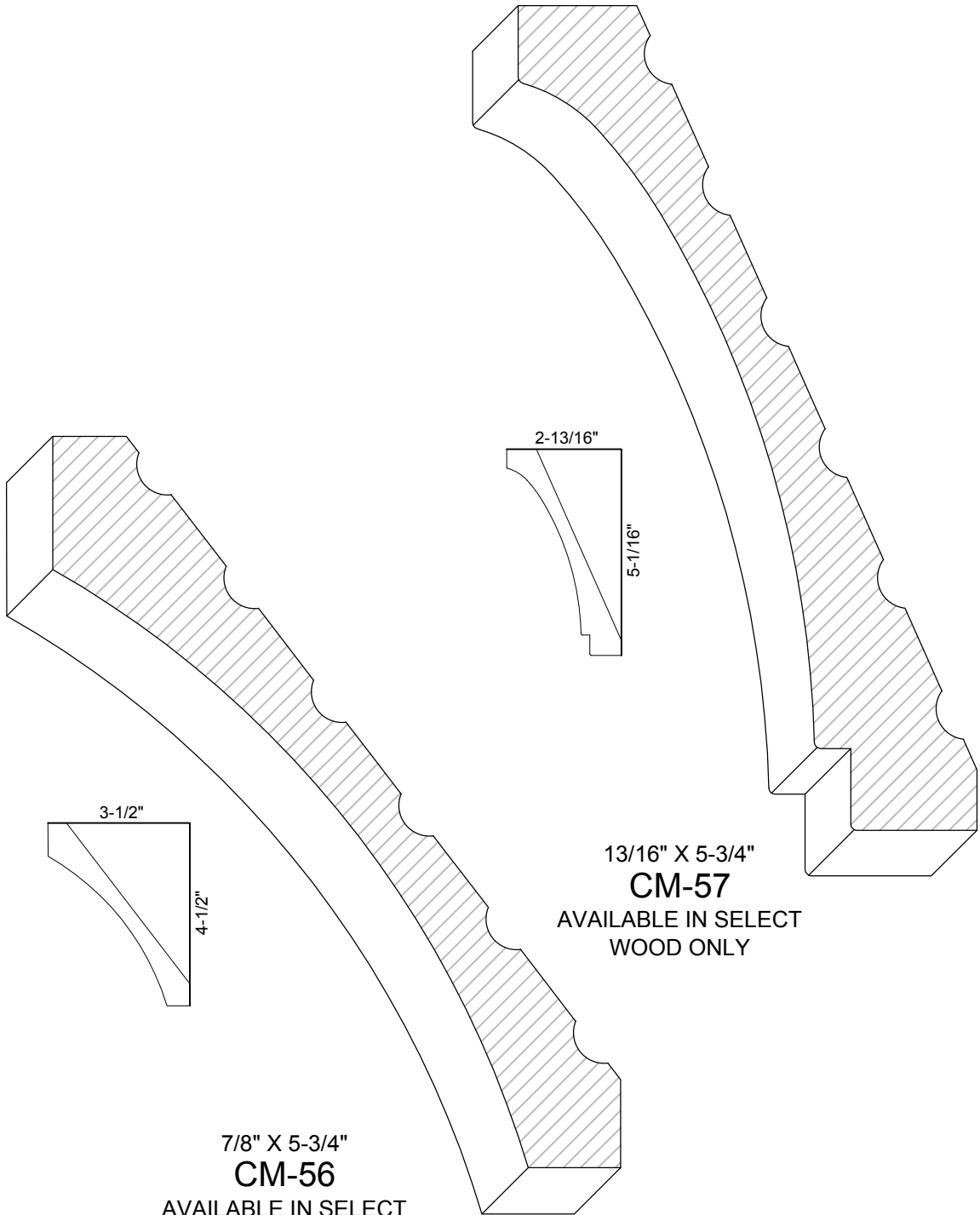

7/8" X 5-3/4"
CM-56
 AVAILABLE IN SELECT
 WOOD ONLY

13/16" X 5-3/4"
CM-57
 AVAILABLE IN SELECT
 WOOD ONLY

CROWN MOULDING

* STOCKED PROFILE



787 N. 2150 W. Circle Cedar City, Utah 84721
 (435) 586-6776 (435) 586-6756 fax

4-3-14

9

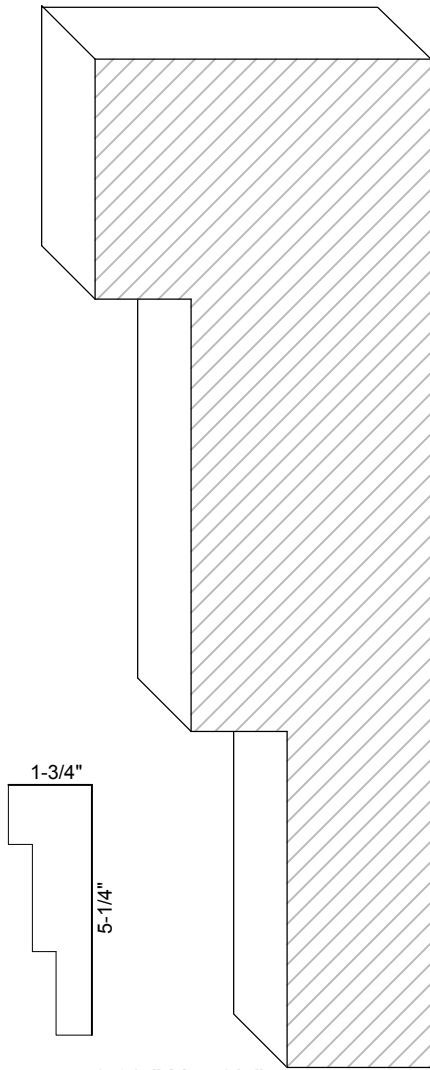

1-3/4" X 5-1/4"
CM-58

CROWN MOULDING

** CALL FOR PRICING

* STOCKED PROFILE



787 N. 2150 W. Circle Cedar City, Utah 84721
(435) 586-6776 (435) 586-6756 fax

4-3-14

10

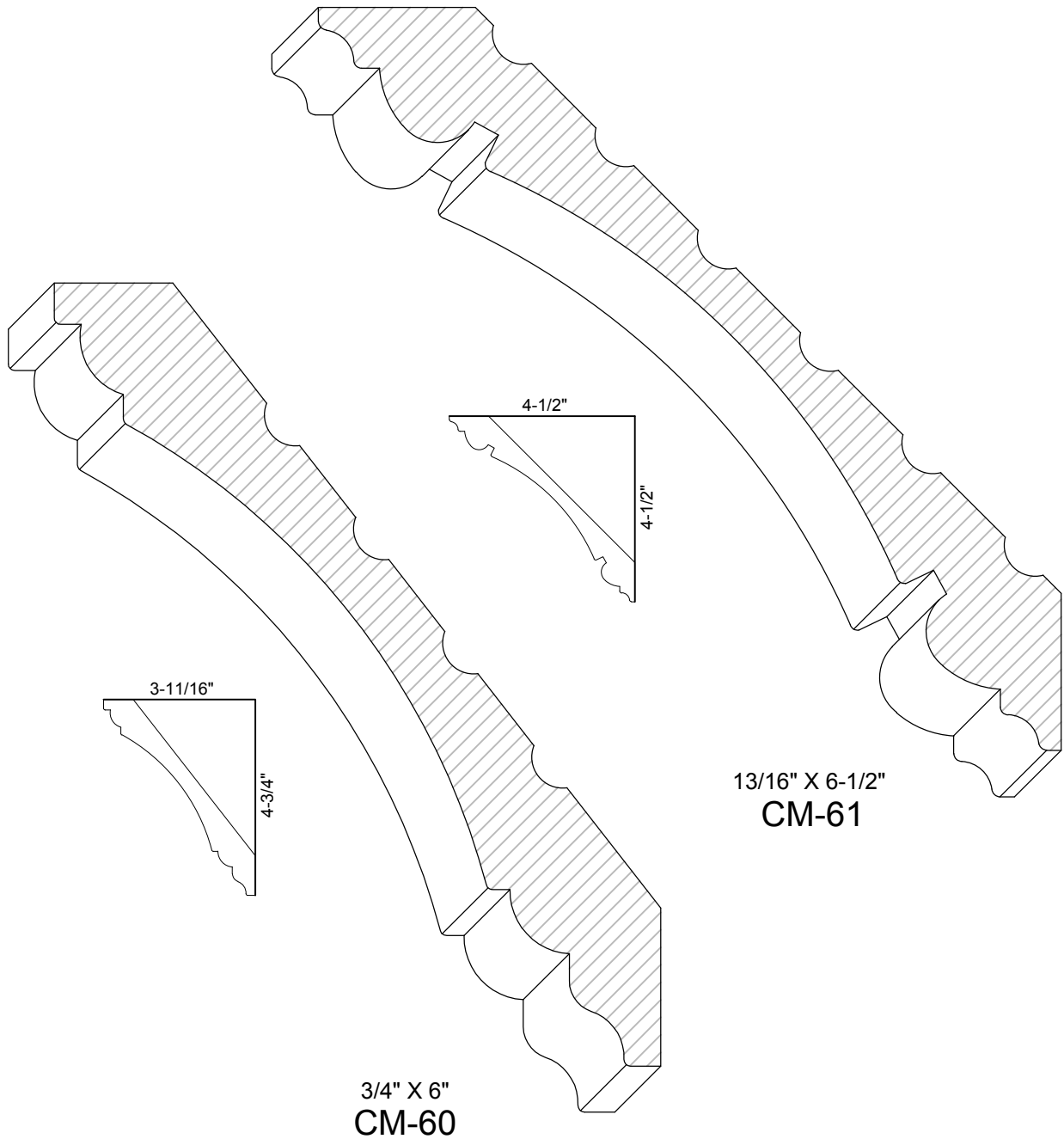

CROWN MOULDING

* STOCKED PROFILE



787 N. 2150 W. Circle Cedar City, Utah 84721
(435) 586-6776 (435) 586-6756 fax

4-3-14

11

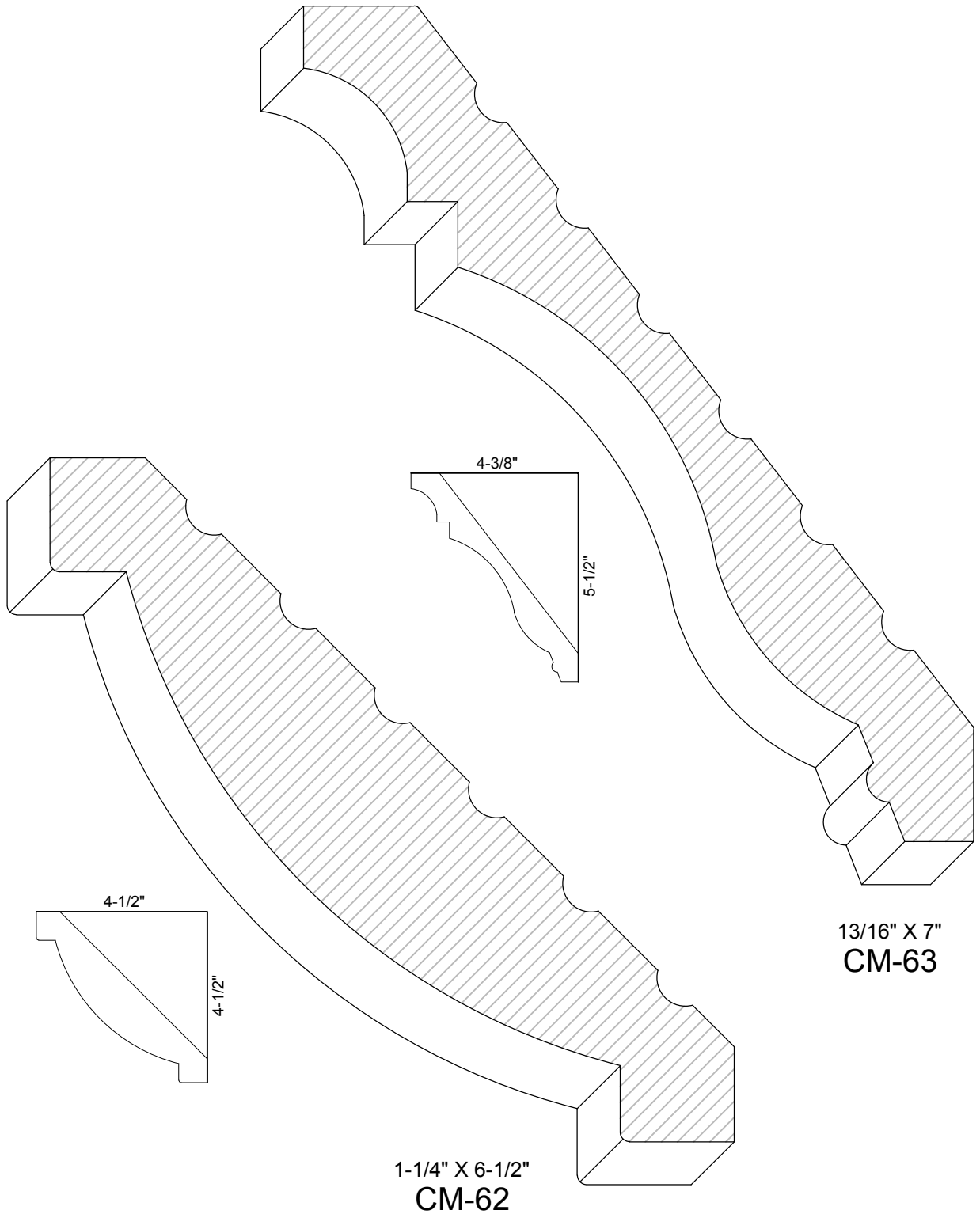

CROWN MOULDING

** CALL FOR PRICING

* STOCKED PROFILE



787 N. 2150 W. Circle Cedar City, Utah 84721
 (435) 586-6776 (435) 586-6756 fax

4-3-14

12

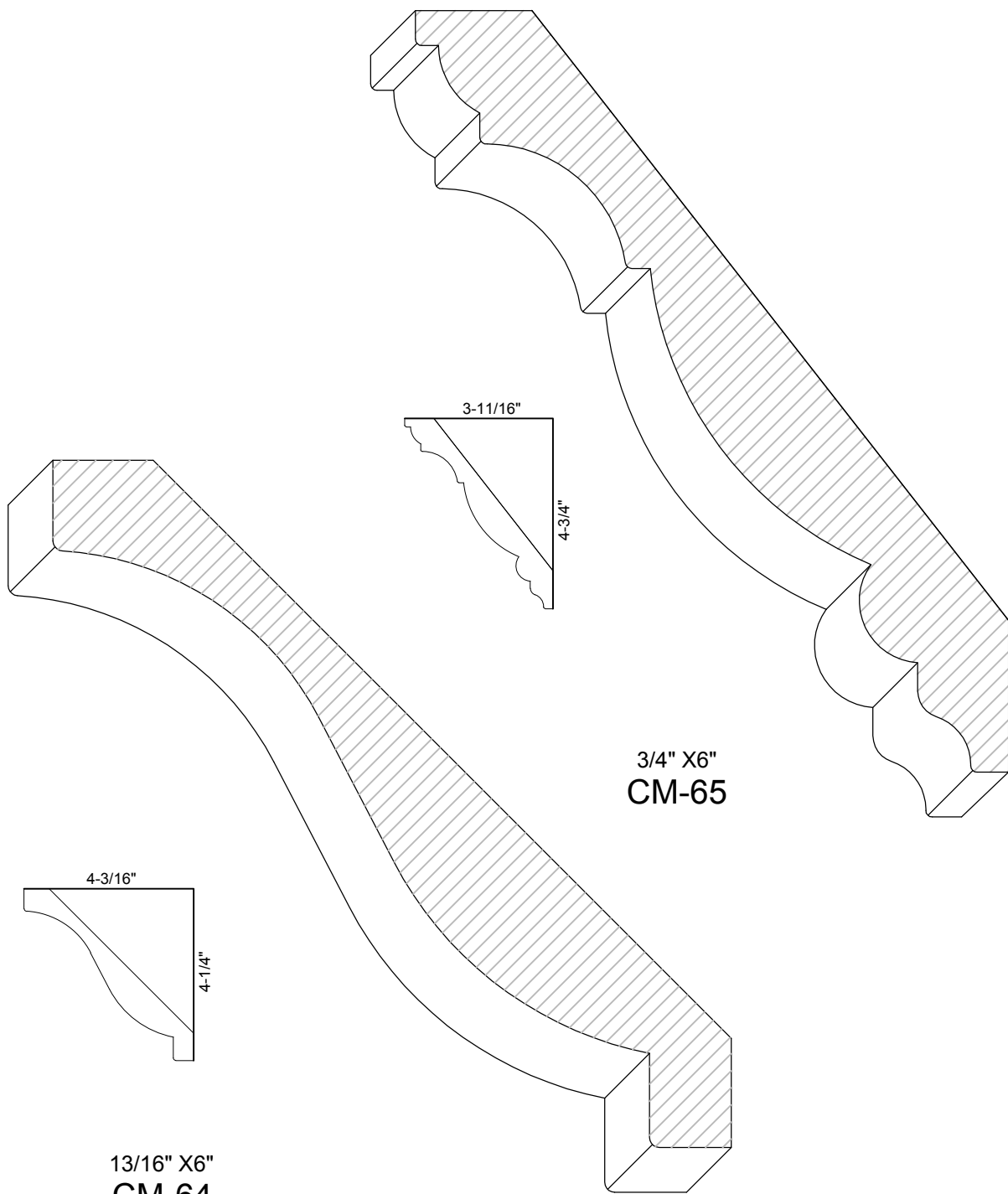

13/16" X6"
CM-64

3/4" X6"
CM-65

CROWN MOULDING

* STOCKED PROFILE



787 N. 2150 W. Circle Cedar City, Utah 84721
(435) 586-6776 (435) 586-6756 fax

4-3-14

13

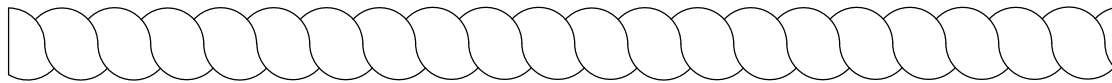

ROPE DETAIL

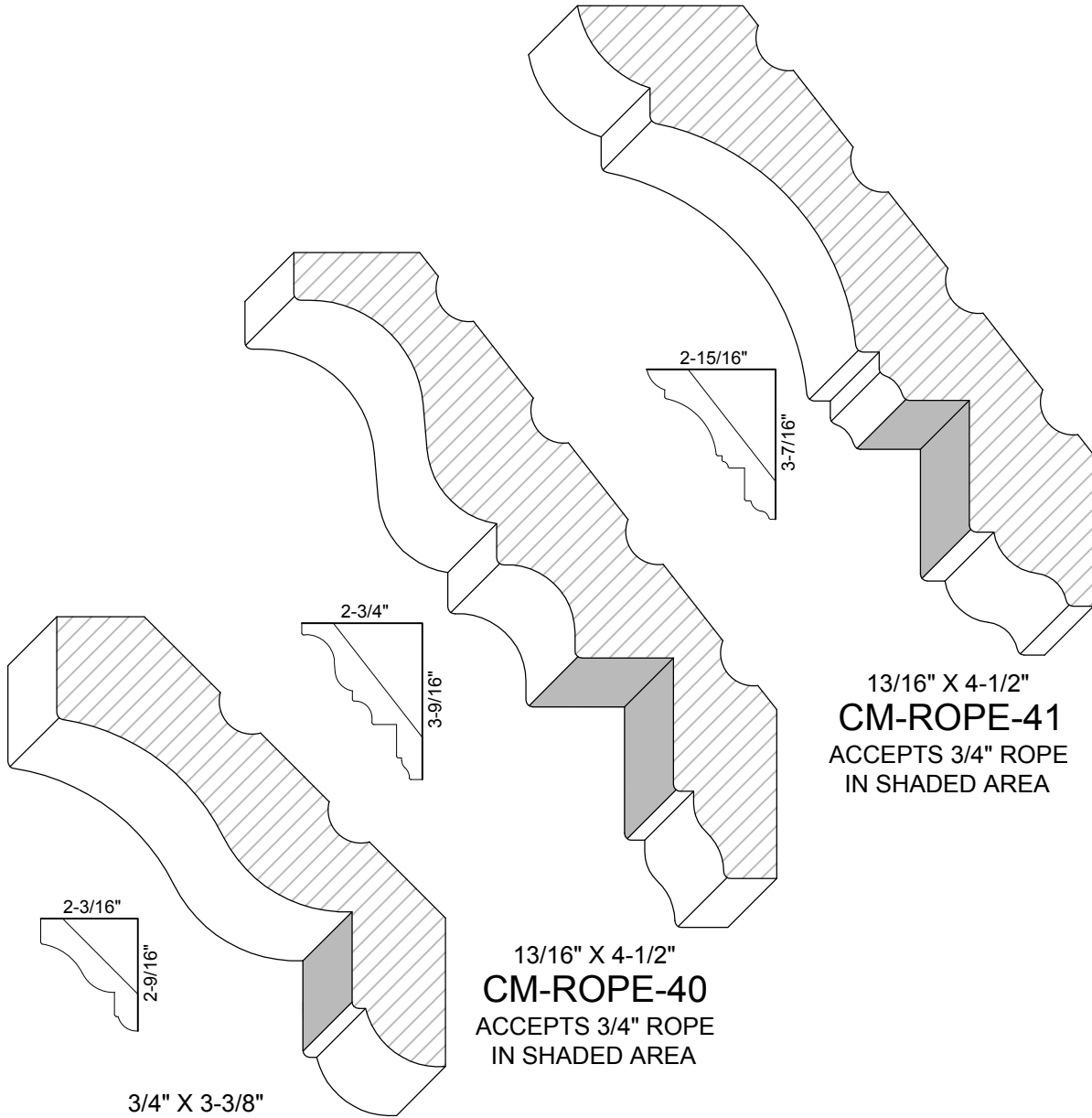

3/4" X 3-3/8"
CM-ROPE-30
ACCEPTS 1/2" ROPE
IN SHADED AREA

13/16" X 4-1/2"
CM-ROPE-40
ACCEPTS 3/4" ROPE
IN SHADED AREA

13/16" X 4-1/2"
CM-ROPE-41
ACCEPTS 3/4" ROPE
IN SHADED AREA

CROWN MOULDING WITH ROPE

* STOCKED PROFILE



787 N. 2150 W. Circle Cedar City, Utah 84721
(435) 586-6776 (435) 586-6756 fax

4-3-14

14

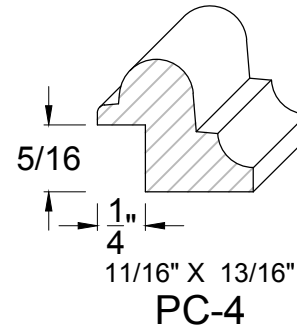
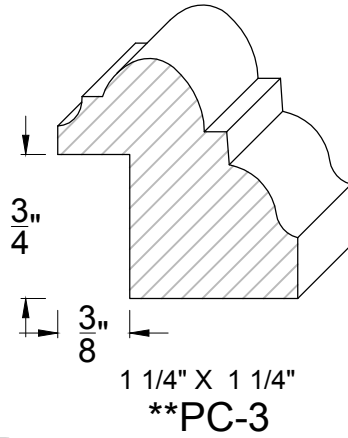
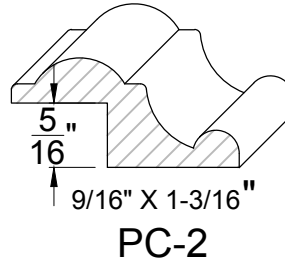
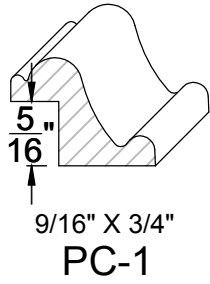

PANEL CAP

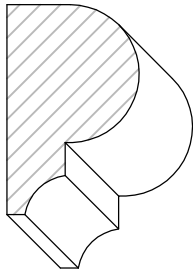

11/16" X 1-1/16"
*NO-1

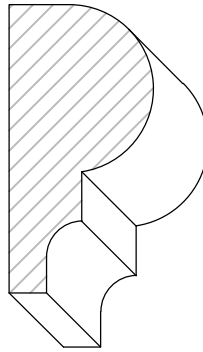

3/4" X 1-1/2"
*NO-2

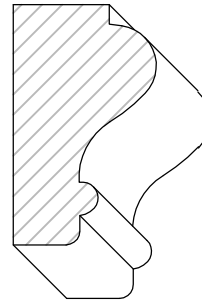

3/4" x 1-1/4"
*NO-3

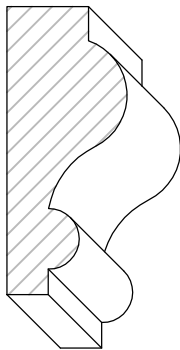

5/8" x 1-1/2"
*NO-4

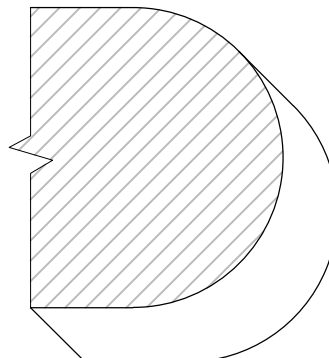

1-9/16" x Variable
**NO-5

NOSING

** CALL FOR PRICING

* STOCKED PROFILE



787 N. 2150 W. Circle Cedar City, Utah 84721
(435) 586-6776 (435) 586-6756 fax

4-3-14

15

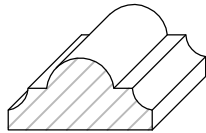

3/8" X 3/4"
*PO-1

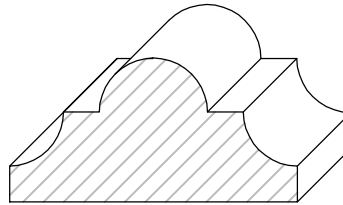

3/4" X 1 1/2"
*PO-2

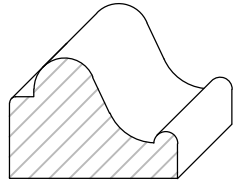

5/8" X 7/8"
*PO-3

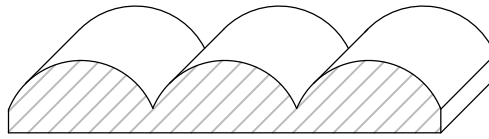

3/8" X 2-1/4"
PO-4

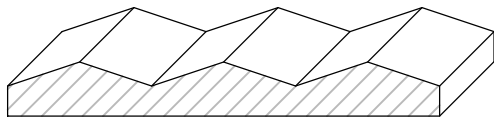

1/4" X 2-1/4"
PO-5

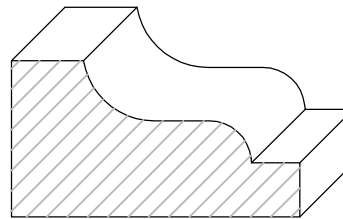

13/16" X 1-1/2"
PO-6

PLANT ON

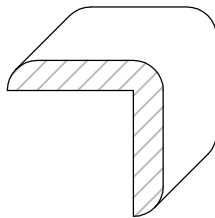

13/16" X 13/16"
CN-1

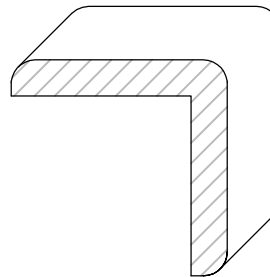

1 1/8" X 1 1/8"
**CN-2

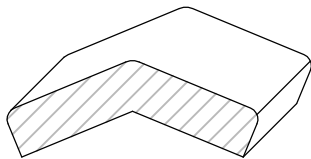

1/2" X 1 1/4"
CN-3

CORNER ROUND

** CALL FOR PRICING

* STOCKED PROFILE



787 N. 2150 W. Circle Cedar City, Utah 84721
(435) 586-6776 (435) 586-6756 fax

4-3-14

16

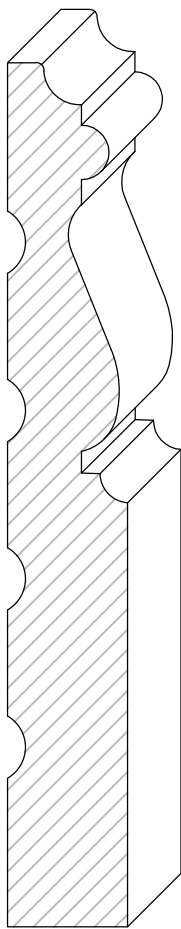

5/8"
*BA-1
6-1/2" MAX.

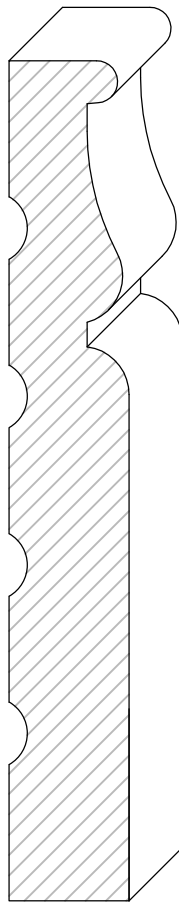

5/8"
BA-2
6" MAX.

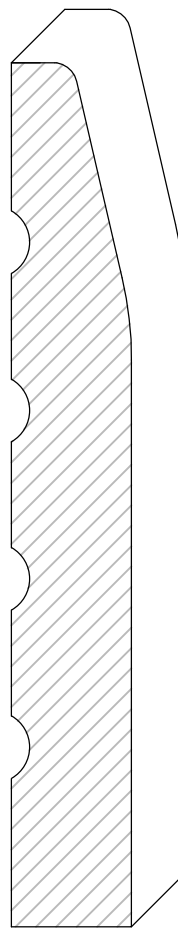

5/8"
BA-3
6-1/2" MAX.

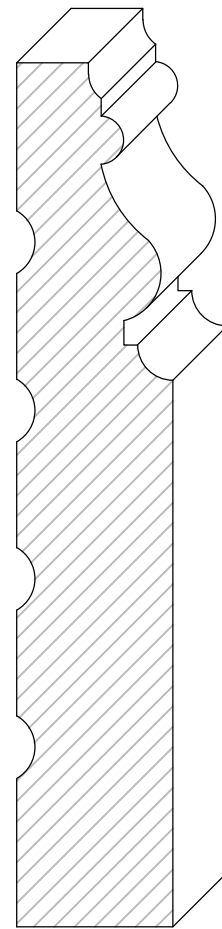

13/16"
BA-4
6-1/4" MAX.

BASE

VARIABLE HEIGHT

* STOCKED PROFILE



787 N. 2150 W. Circle Cedar City, Utah 84721
(435) 586-6776 (435) 586-6756 fax

4-3-14

17

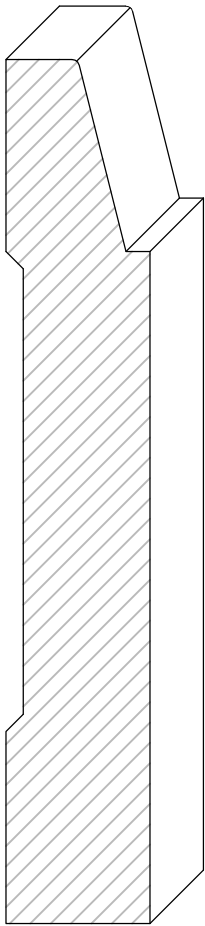

3/4"
BA-9
7" MAX.

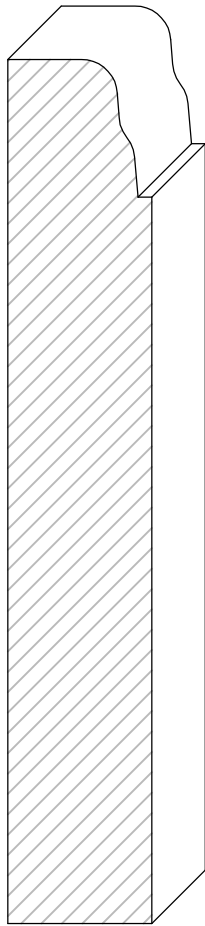

3/4"
BA-10
7" MAX.

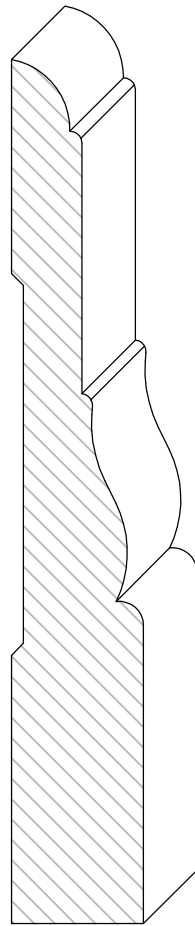

3/4"
BA-11
6-1/4" MAX.

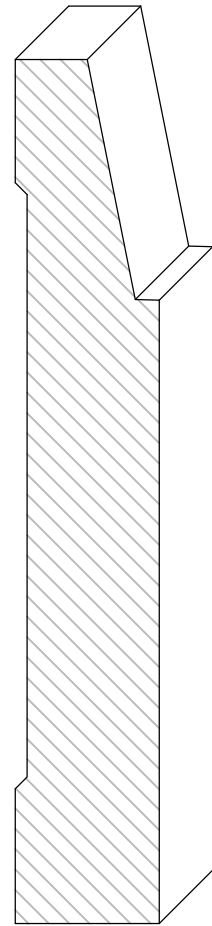

3/4"
BA-12
7" MAX.

BASE

VARIABLE HEIGHT

* STOCKED PROFILE



787 N. 2150 W. Circle Cedar City, Utah 84721
(435) 586-6776 (435) 586-6756 fax

4-3-14

19

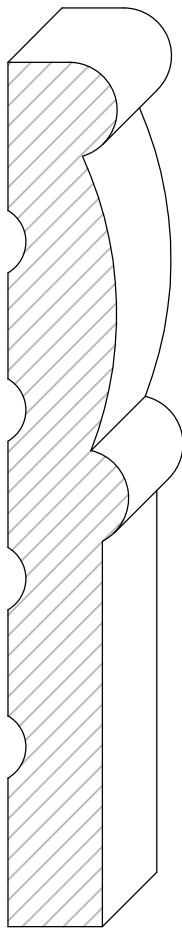

5/8"
BA-5
7" MAX.

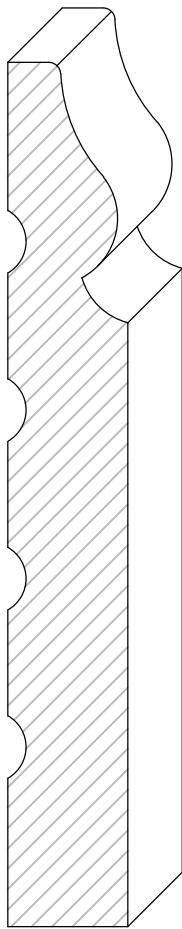

5/8"
BA-6
6-3/8" MAX.

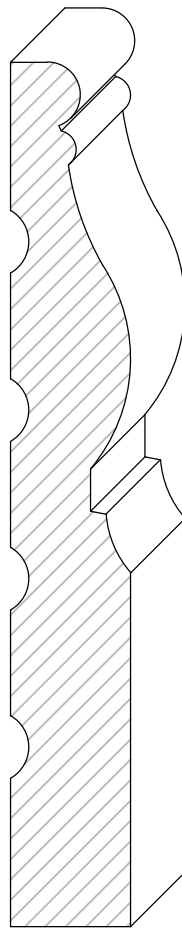

5/8"
BA-7
6" MAX.

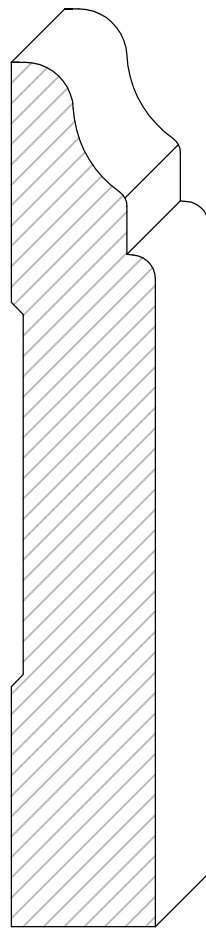

3/4"
BA-8
6" MAX.

BASE

VARIABLE HEIGHT

* STOCKED PROFILE



787 N. 2150 W. Circle Cedar City, Utah 84721
(435) 586-6776 (435) 586-6756 fax

4-3-14

18

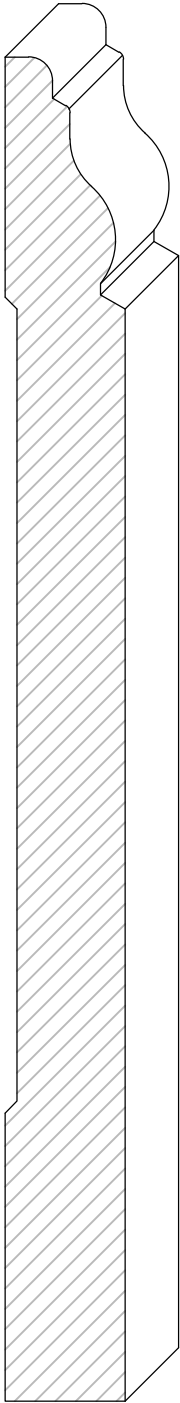

5/8"
BA-13
7" MAX.

BASE

VARIABLE HEIGHT

* STOCKED PROFILE



787 N. 2150 W. Circle Cedar City, Utah 84721
(435) 586-6776 (435) 586-6756 fax

4-3-14

20

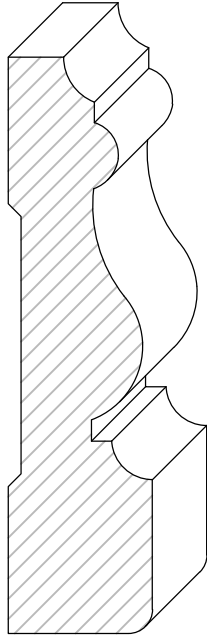

3/4" X 3"
CA-1

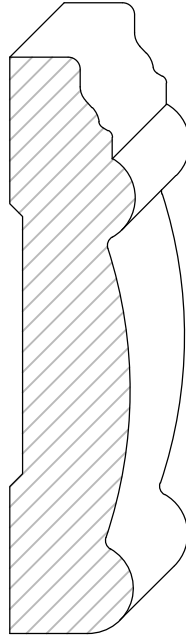

13/16" X 3"
CA-2

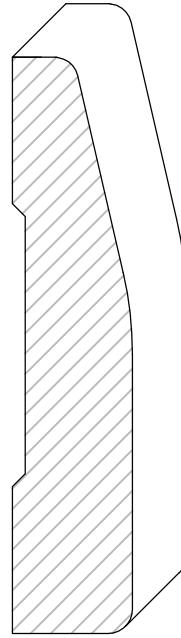

5/8" X 3"
CA-3

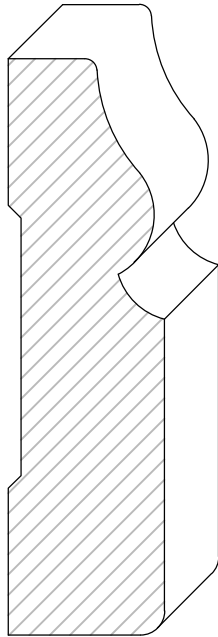

13/16" X 3"
CA-6

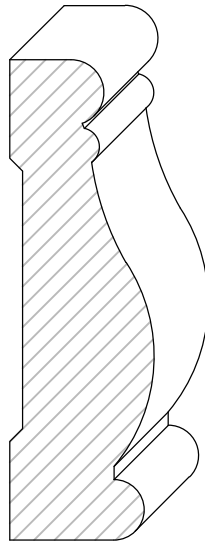

3/4" X 2-1/2"
CA-7

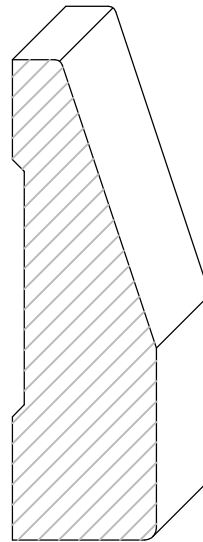

3/4" X 2-1/2"
CA-8

CASE & CHAIR RAIL

* STOCKED PROFILE



787 N. 2150 W. Circle Cedar City, Utah 84721
(435) 586-6776 (435) 586-6756 fax

4-3-14

21

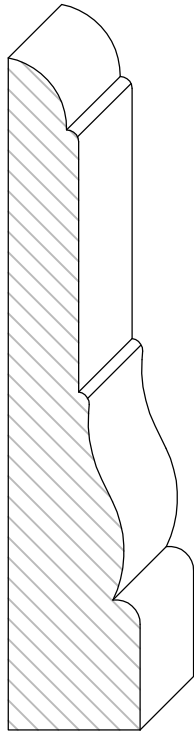

3/4" X 3-1/2"
CA-11

CASE & CHAIR RAIL

* STOCKED PROFILE



787 N. 2150 W. Circle Cedar City, Utah 84721
(435) 586-6776 (435) 586-6756 fax

4-3-14

22

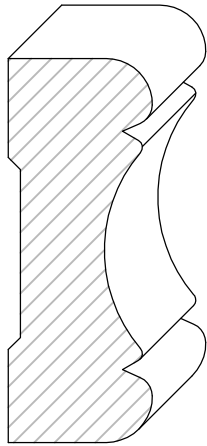

3/4"X2"
CHRL-1

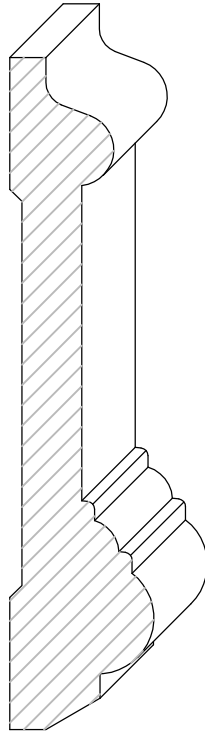

3/4"X3-1/2"
CHRL-2

CHAIR RAIL

* STOCKED PROFILE



787 N. 2150 W. Circle Cedar City, Utah 84721
(435) 586-6776 (435) 586-6756 fax

4-3-14

23

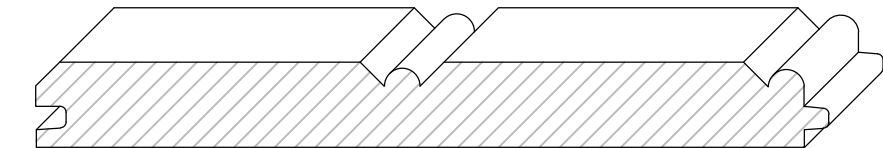

7/16" X 4-1/8"
*TG-1

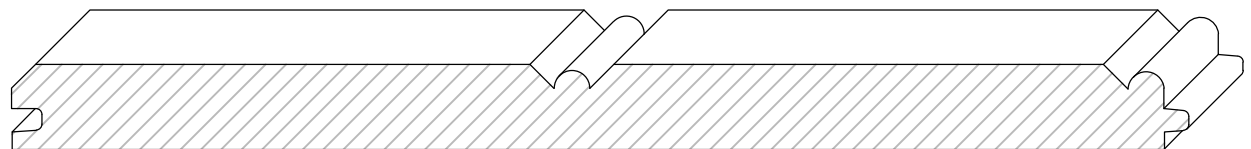

7/16" X 6-1/8"
TG-2

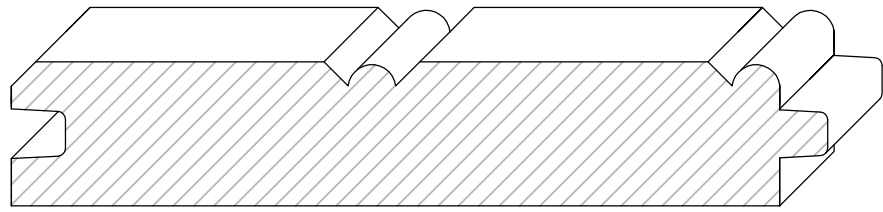

3/4" X 4-1/4"
TG-3

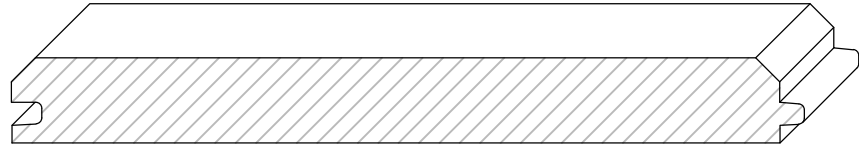

7/16" 4-1/8"
TG-4

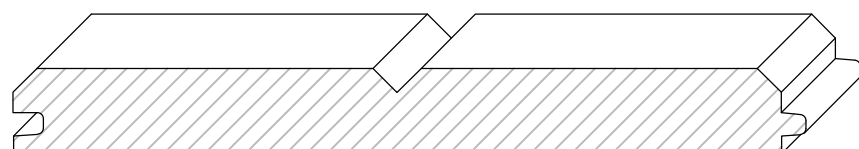

7/16" 4-1/8"
TG-5

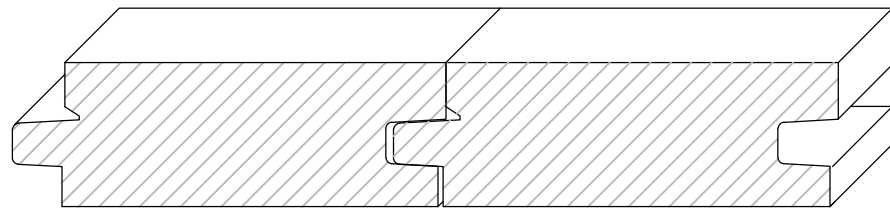

3/4" X VARIABLE
TG-6

TONGUE & GROOVE

* STOCKED PROFILE



787 N. 2150 W. Circle Cedar City, Utah 84721
(435) 586-6776 (435) 586-6756 fax

4-3-14

24

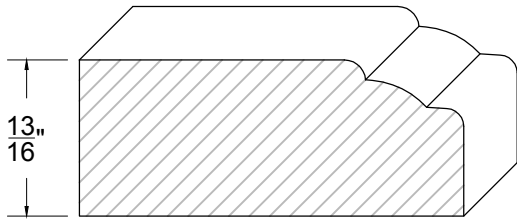

SC-1

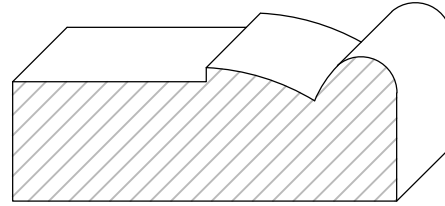

SC-2

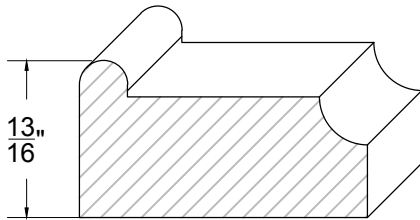

SC-3

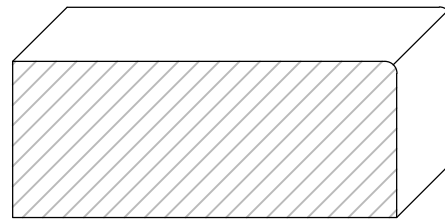

SC-4

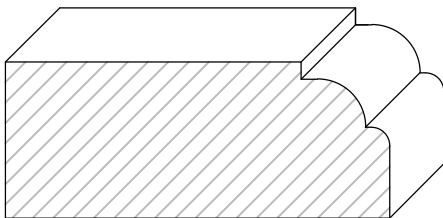

SC-5

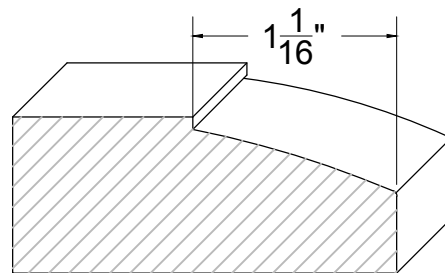

SC-7

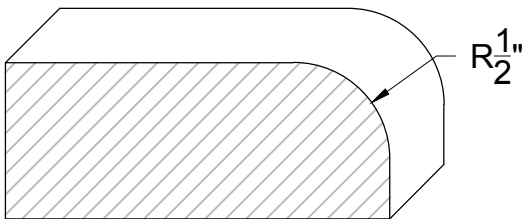

SC-8

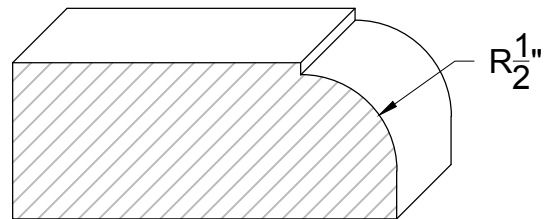

SC-9

STARTER CROWN

3/4" X VARIABLE

***STOCKED PROFILE**



787 N. 2150 W. Circle Cedar City, Utah 84721
(435) 586-6776 (435) 586-6756 fax

4-3-14

25

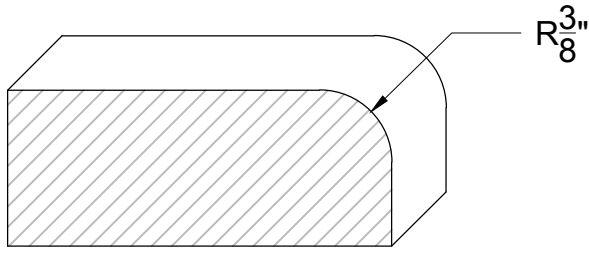

SC-10

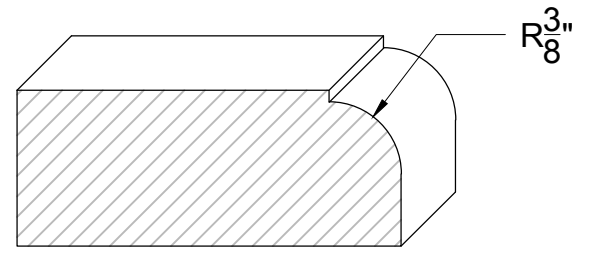

SC-11

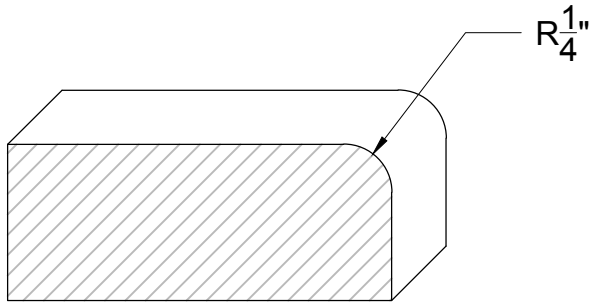

SC-12

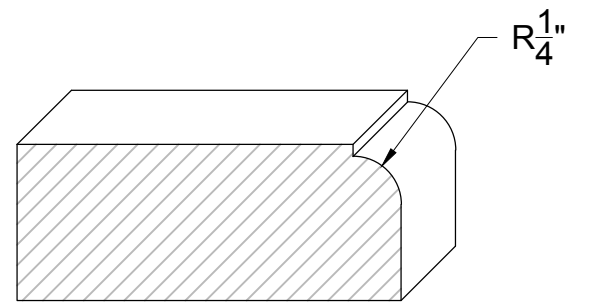

SC-13

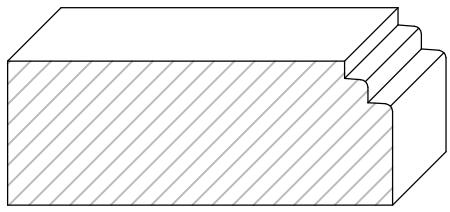

SC-15

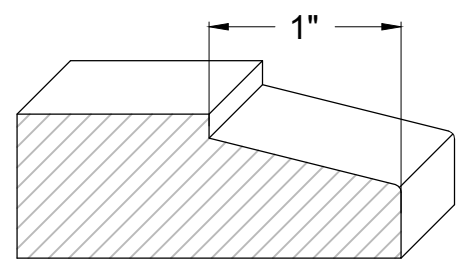

SC-16

STARTER CROWN

3/4" X VARIABLE

* STOCKED PROFILE



787 N. 2150 W. Circle Cedar City, Utah 84721
 (435) 586-6776 (435) 586-6756 fax

4-3-14

26

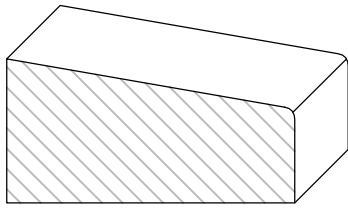

3/4" X 1-1/2"
TR-1

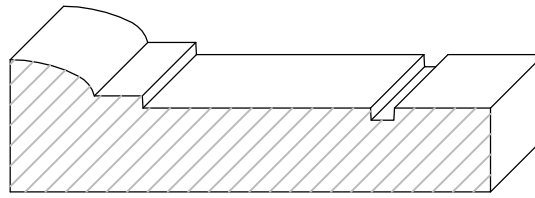

11/16" X 2-1/2"
TR-2

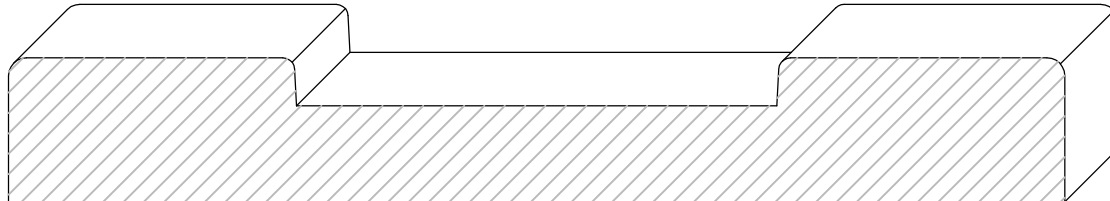

3/4" X 5-1/2"
TR-3

TRIM

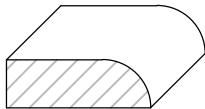

5/16" X VARIABLE
ST-1
3/4" MIN. WIDTH

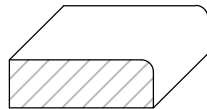

5/16" X VARIABLE
ST-2
7/8" MIN. WIDTH

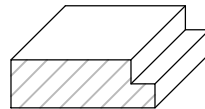

5/16" X VARIABLE
ST-3
3/4" MIN. WIDTH

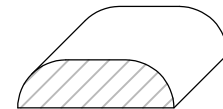

1/4" X VARIABLE
ST-4
3/4" MIN. WIDTH

SCRIBE TRIM

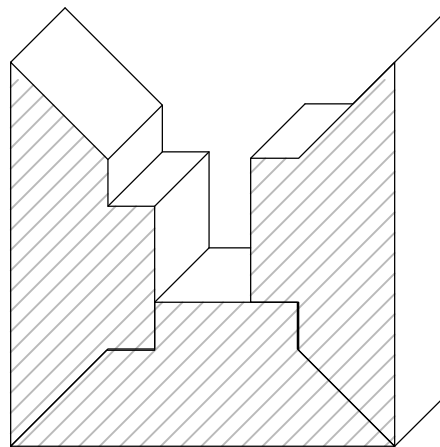

3/4" X VARIABLE
BB-1

BOX BEAM

* STOCKED PROFILE



787 N. 2150 W. Circle Cedar City, Utah 84721
(435) 586-6776 (435) 586-6756 fax

4-3-14

27

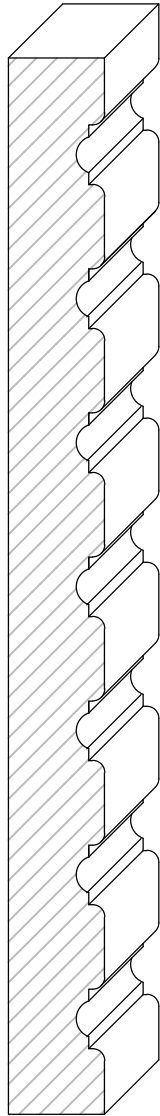

1/2" X VARIABLE
5-1/2" MAX.
FL-1

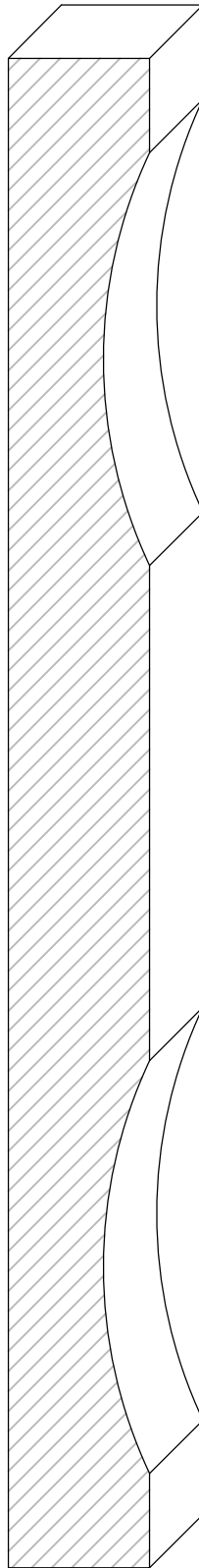

3/4" X 8"
FL-2

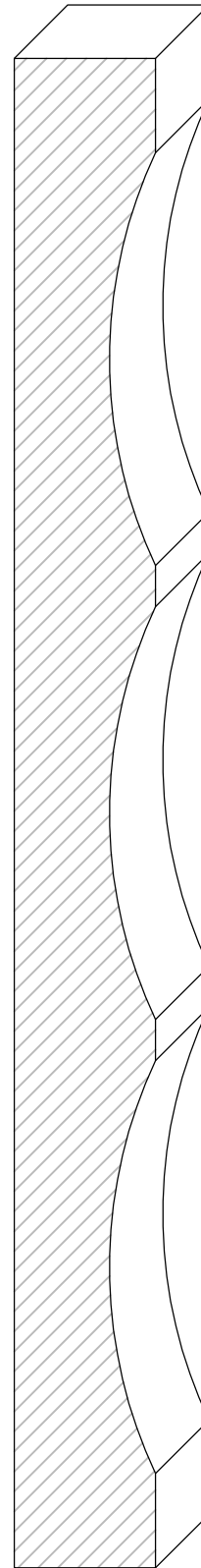

3/4" X 8"
FL-3

FLUTING

* STOCKED PROFILE



787 N. 2150 W. Circle Cedar City, Utah 84721
(435) 586-6776 (435) 586-6756 fax

4-3-14

28